



**TCT Circular Saw Blades
PCD Circular Saw Blades
Band Saw Blades**



— 2021



The production of wood cutting tools began in Hulín, Czechoslovakia as far back as in the year **1934** when „*The First Moravian Factory for Production of Saws and Tools*“ started its operations. Initially, hand held saws were the main product, gradually circular saw blades were added to the production program along with other cutting tools for wood. In the **1960s**, the product range expanded as TCT tipped circular saw blades were added.

During the **1990s**, privatization of the state owned manufacturing facilities into private hands occurred and as a result of this process company PILANA Wood was formed. Enormous efforts were brought into upgrading the machinery park, improvement of the production technologies and general shifting to western standards so that the company could become competitive in the newly opened world markets after the fall of the Eastern Block.

These new production technologies include cutting of steel bodies by laser and their machine straightening or brazing and sharpening of TCT tips. Machinery park has been constantly renewed to presently contain robotic brazing machines made by Kirschner, DE or sharpening centers made by Vollmer, DE. Strict quality control has also become one of the crucial pillars on which the whole production stands and is now an inseparable part of the overall modern approach to managing our business.

At present, we are happy to serve our customers in **more than 90 countries** of the world where they can choose from a variety of standard products available from stock as well as tools made on request. That all for applications in cutting of wood, chipboard, plastics, non-ferrous metals, steels and many other contemporary materials.

You are cordially invited to come and try the quality of our products and services for yourselves.

TCT Circular Saw Blades – General Information	3 - 8
Primary Wood Processing	9 - 20
TCT Multirip Saw Blades for Primary Wood Processing	10 - 11
TCT Saw Blades For Multirip Machines	12 - 17
TCT Saw Blades HANIBAL, LUCAS, ECOPRO	18
TCT Saw Segments for Flakers	19 - 20
Secondary Wood Processing	21 - 32
TCT Saw Blades for Wood Cutting	22 - 26
TCT Saw Blades for Constructions / Pruning	27
TCT Saw Blades for Wood Cutting / TCT Cross Cut and Cut Off Saw Blades for Optimising Saws	28
TCT Saw Blades for Miter Saws / Trimming Applications	29
TCT Saw Blades for CNC Machines / TCT Grooving Saw Blades	30
TCT Saw Blades for Grooving / TCT Saw Blades for Grooving in Biscuit Joining	31
TCT Saw Blades for Portable Circular Saws	32
TCT Sizing Saw Blades	33 - 40
TCT Panel Sizing Saw Blades HIGH PROFI+	34
TCT Scoring Saw Blades HIGH PROFI	35
TCT Sizing Saw Blades HIGH PROFI+ / HIGH PROFI	36
TCT Sizing Saw Blades	37 - 40
TCT Sizing Saw Blades / TCT Scoring Saw Blades	41
TCT Scoring Saw Blades	42
TCT Saw Blades and Segments for Hogging Machines	43
TCT Saw Blades for Non-Ferrous Metals, Thin Walled Profiles, Plastics and Dry-cutting	44 - 50
TCT Saw Blades for Cutting of Non-Ferrous Metals and Plastics	45 - 47
TCT Saw Blades for Cutting of Thin Walled Profiles	48
TCT Saw Blades for Cutting of Building Materials, DRY CUT Saw Blades	49
TCT Saw Blades for Cutting of Non-Ferrous Metals and Plastics	50

TCT or CERMET Saw Blades for Steel Cutting	51 - 58
TCT Saw Blades for Steel Cutting	52 - 53
TCT Saw Blades for Tube/Profile Cutting	54 - 55
TCT Saw Blades for Steel Cutting	56 - 57
TCT Saw Blades for Steel Cutting - General Information	58
Special TCT Saw Blades, Segments Reduction and Distance Rings	59 - 62
TCT Saw Blades for Mineral / Rock Wool	60
TCT Saw Blades for Use in Food Industry	61
Reduction Rings / Distance Rings / Hogging Heads	62
TCT Segments Accessories	62
PCD Saw Blades	63 - 64
PCD Saw Blades	64
Band Saw Blades for Wood	65 - 69
Recommendations How to Use Band Saw Blades	66 - 67
Band Saw Blades for Wood - WM	68
Scoring Saw Blades for Wide Band Saws	69
Band Saw Blades for Wood - Joinery Types	69
Notes	70

pilana.com



pilanawood.com

General Information



Tungsten carbide tipped (TCT) circular saw blades from PILANA Wood are manufactured from high quality German steels with the use of TCT tips made for specific application based on their hardness/tenacity grade. Bodies have typically the hardness of 45-48 HRC and the complete saw bodies are laser-cut.

Expansion slots located around the saw body are specially shaped for each cutting application. As a result, they prevent blade deformation and improve cutting quality in difficult working conditions. Low-noise slots in the steel saw body reduce noise generated by the saw in the movement and allow for pleasant working conditions.

High attention is also paid to the saw blade stability, tolerances of the outer and side run and tensioning of the body thus reaching the best cutting results possible. The last but not least important parameter is the sharpening of the TCT carbide tips - ideal cutting edge/tooth shape guarantees optimal quality cutting.

Constantly renewed machine park (Vollmer sharpening machines, Kirschner and Gerling brazing machines, Trumpf lasering machines etc.) together with the best quality grinding discs/soldering material enable us to sustain high top quality of our saw blades for our customers of more than 90 countries in the world.

Tooth Geometry of TCT Circular Saw Blades

	FZ	flat tooth		TFZ	triple chip tooth alternating with flat tooth		alternate top and axial bevel
	FZ N	flat tooth with negative hook angle		TFZ N	triple chip tooth alternating with flat tooth with negative hook angle		
	LFZ	flat tooth with chip limiter					
	WZ	alternate top bevel		DHZ	hollow face tooth (flat tooth alternates with inverted "V" tooth)	WZ/FA	flat tooth with bevel
	WZ N	alternate top bevel with negative hook angle		DHZ N	hollow face tooth (flat tooth alternates with inverted "V" tooth), negative hook angle		
	LWZ	alternate top bevel with chip limiter					
	TZ	triple chip tooth		KON FZ	conical tooth	WZ/W	alternate tooth with double bevel
	TZ/TZ			KON WZ			
	KXZ FZ	barrel tooth		WZ/FA/K	plexi	WZ/FA/N	flat tooth with bevel with negative hook angle

List of Carbide Tip Grades:

Grades of tips			
K 01	K 10	K 20	K 30
Hardness [HV 30]	Hardness [HV 30]	Hardness [HV 30]	Hardness [HV 30]
1900 – 2250	1740 – 1800	1520 – 1600	1140 – 1510
Tips of K01 grade are very resistible against abrasion. Powdered grain (ultra fine grain) is very fine. Its grade is applicable for cutting hard materials. For example MDF, chipboard, HDF, double side laminated chipboard etc.	Tips with optimal combination of fine-grained structure and material hardness applicable for universal usage. Best for cutting wood, plastics, non – ferrous metals, plywood, plaster boards etc.	Tips containing higher percentage of cobalt binding material enable better tooth tenacity and therefore higher resistance while encountering other material types (branch knots, dirt, steel chips etc.). Tips are applicable for cutting along the grain of natural woods.	High percentage of cobalt binding material with lower hardness enables K30 tips high tenacity and resistance against breaking. This grade is best applicable for cutting in extreme conditions (i.e. cutting frozen wood).

Hardness

Tenacity

Saw Blade Alignment on a Table Saw

In order to reach the best performance of a saw blade, the overhang of the saw blade teeth over the cutting material must be equal to the height of the tungsten tip (see P in picture no. 1).

The number of teeth cutting simultaneously in the material must be between 2-3.

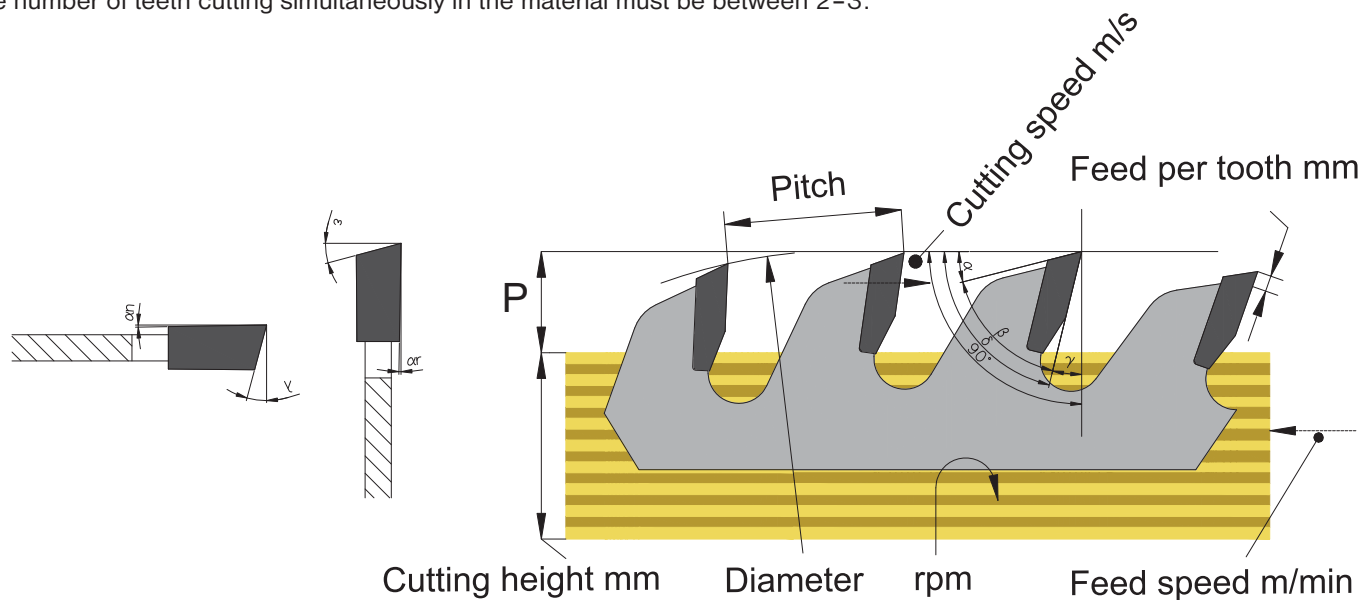

Pict. no. 1

Tab. no. 1

Recommended values of feed/tooth		
Cutting speed	Feed speed (mm/tooth)	Material
60-100	0,1-0,35	dry transverse
60-100	0,15-0,5	dry longitudinal
50-90	0,06-0,15	hard wood
60-100	0,6-1,5	pre-saw
60-80	0,05-0,12	laminated
60-90	0,05-0,15	veneer
50-80	0,1-0,3	chipboard
50-70	0,05-0,12	plastic
50-80	0,03-0,1	plexi, bakelite
30-70	0,03-0,15	plastic profile
30-70	0,01-0,08	aluminium
7-20	0,02-0,05	copper
40-60	0,1-0,3	heraclitus
50-70	0,1-0,25	plasterboard
50-80	0,05-0,25	plywood
50-70	0,05-0,12	corian
60-90	0,05-0,25	MDF,HDF
15-60	0,02-0,1	aluminium alloys
50-70	0,02-0,1	HPL
20-45	0,07-0,15	mineral woold
3-10	0,02-0,08	bronze
50-70	0,1-0,3	paper
40-60	0,03-0,1	cement board
25-35	0,01-0,02	dry cut

Index of angles in a saw blade	
α	clearance angle
α_n	tangential clearance angle
α_r	radial clearance angle
β	wedge angle
γ	hook angle
δ	cut angle = $\alpha + \beta$
λ	shear angle
ϵ	bevel angle

Tab. no. 2 Cutting speed m/s

D [mm]	RPM														
	1500	2000	2500	2850	3000	4000	4500	5000	5600	6000	8000	9000	10000	12000	18000
ø 80	6,5	8,5	10,5	12	13	17	19	21	23,5	26	34	38	42	52	76
ø 90	7	9,5	12	13,5	14	19	21	24	26,5	28	38	42	48	56	84
ø 100	8	10,5	13	15	16	21	24	26	29	32	42	48	52	54	96
ø 120	9,5	13	16	18	19	26	28	32	35	38	52	56	64	76	112
ø 125	10	13,5	16,5	18,5	19,5	27	29	33	36,5	39	54	59	66	78	118
ø 140	11	15	18	21	22	30	33	36	41	44	60	66	72	88	132
ø 150	12	15,5	19,5	22,5	23,5	31,5	33,5	39	44	47	63	70,5	78,5	94,5	141,5
ø 160	13	17	21	24	26	34	38	42	48	52	68	76	84	104	152
ø 180	14	19	24	27	28	38	42,5	48	53	56	76	85	96	118	170
ø 200	16	21	26	30	32	42	47	52	58,5	64	84	94	104	128	188
ø 225	18	24	30	33,5	36	48	58	60	66	72	96	106	120	144	212
ø 250	20	26	33	37	40	52	59	66	73,5	80	104	118	132	160	236
ø 300	24	31,5	40	45	48	63	71	80	88	96	126	142	160	192	284
ø 350	28	36,5	47	52	56	73	88	94	105	112	146	166	188	224	332
ø 400	32	42	54	60	64	84	94	108	117	128	168	188	216	256	376
ø 450	35,5	47	59	67,5	70,5	94,5	106	118	132	141,6	188	211	236	283	424
ø 500	40	53	67	74,5	80	106	118	134	146,5	160	212	236	268	320	472

Tab. no. 2 shows the maximum RPM of circular saw blade based on the diameter of the blade. RPM referring to cutting speed 100 m/sec. These are the maximum recommended RPM by the machine producer. When exceeding this limit, the blade may lose its characteristics and danger to user may occur.

Tab. no. 3

D [mm]	Recommended RPM [1/min]									
	Cutting speed v_c [m/sec]									
	10	20	30	40	50	60	70	80	90	100
100	1910	3820	5730	7640	9550	11460	13370	15280	17190	19100
150	1270	2550	3820	5100	6370	7640	8920	10190	11500	12730
200	960	1910	2870	3820	4780	5730	6690	7640	8600	9550
250	760	1530	2290	3060	3820	4590	5350	6110	6880	7640
300	640	1270	1910	2550	3180	3820	4460	5100	5740	6370
350	550	1090	1640	2180	2730	3280	3820	4370	4900	5460
400	480	960	1430	1910	2390	2870	3340	3820	4300	4780
450	430	850	1270	1700	2120	2550	2970	3400	3820	4250
500	380	760	1150	1530	1910	2290	2680	3060	3440	3820
550	350	690	1040	1390	1740	2080	2430	2780	3120	3470
600	320	640	960	1270	1590	1910	2230	2550	2880	3180
650	290	590	880	1180	1470	1760	2060	2350	2640	2940
700	270	550	820	1090	1360	1640	1910	2180	2450	2730
750	250	510	760	1020	1270	1530	1780	2040	2290	2550
800	240	480	720	950	1190	1430	1670	1910	2150	2390

$$v_c = \frac{D \times \pi \times n}{1000 \times 60}$$

$$n = \frac{1000 \times 60 \times v_c}{D \times \pi}$$

$$s = \frac{s_z \times n \times z}{1000}$$

Here are some useful formulas to help you calculate the correct number of teeth on saw blades:

$$t = \frac{h \times 1,45}{k}$$

$$z = \frac{D \times \pi}{t}$$

Key:

- t [mm] – tooth pitch
- h [mm] – thickness of the work piece
- k [-] – number of teeth in cutting place (2÷3)
- z [-] – number of teeth of the saw blade
- D [mm] – sawblade diameter



INSTRUCTIONS HOW TO USE SAW BLADES CORRECTLY

We recommend to follow the below rules in order to reach the best cutting results:

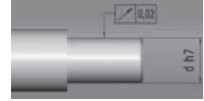

Pict. no. 2

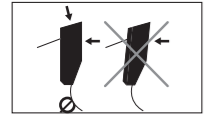

Pict. no. 3



Pict. no. 4

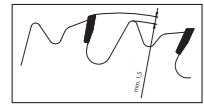

Pict. no. 5

- Machine must be in good condition without vibrations

Recommended Diameters for Flange

Diameter of Saw Blade (mm)	200	250 - 300	350 - 450	500 - 700
Flange Diameter (mm)	70	80 - 100	100 - 140	140 - 160

- Flanges must be clean and it is important to check their side run - out
- Check the spindle of the machine. It must be absolutely straight (picture 2)
- Tips must always be sharpened with the original angles
- See the most appropriate way of sharpening (picture 3)
- If rebored by over 20mm, the blade loses its original features and its stability (picture 4)
- In saw blades with chip limiter, it is necessary to grind the TCT and the chip limiter to keep the oversize of the TCT (picture 5)

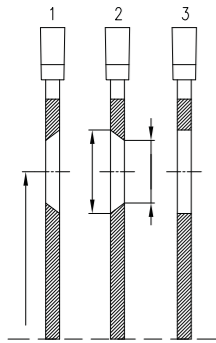

TYPE 1
Countersink right

TYPE 2
Countersink left

TYPE 3
Pinhole without countersink

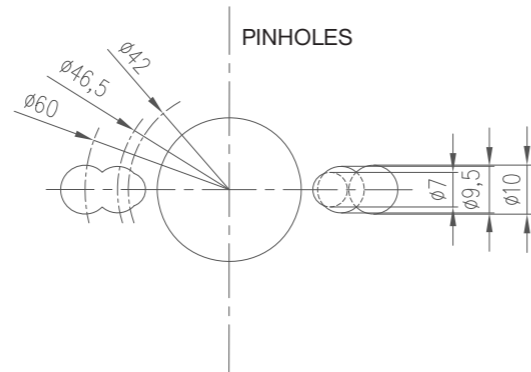

FREQUENTLY ASKED QUESTIONS

WHAT CAN I DO TO OBTAIN BETTER CUTTING SURFACE FINISH?	Choose saw blade with more teeth
	Use higher peripheral speed
	Select saw blade with different tooth shape
	Check flanges and distances
	Check condition of spindle bearing
BLADE IS VERY NOISY, ESPECIALLY WHEN IDLING, WHY?	Blade goes into oscillation (self-vibration)
	Change number of teeth and diameter
	Adjust speed of revolutions if possible
	Choose sound absorbing saw blade
HOW TO AVOID CHIPPING OUT ON THE BOTTOM SIDE OF THE MATERIAL?	A coating of sound absorbing material on the inside of the safety cover.
	Use saw blade with more teeth
	Saw blade is positioned too high above cutting material
WHY DOES SAW BLADE WOBBLE WHEN WARM?	Choose different tooth shape and angles
	During cutting saw blade becomes warm, especially on the periphery, which causes its expansion and stretching. Adding expansion slots improves blade's properties
HOW TO AVOID BLADE CHOPPING WHEN CUTTING ALUMINIUM?	When using manual feed, negative hook angle results in softer cut, saw blade with more teeth also results in softer cutting edge
	Positive hook angle is used in automatic feed, saw blade with more teeth results in softer cutting edge

TROUBLESHOOTING CHART

Problem	Possible cause	Action
Saw blade wobbles	Thickness of the tool body is too small	Select saw blade with large kerf or smaller diameter or increase flange diameter
	Insufficient tooth projection over tool body (saw blade jams in the cut, runs hot, tension lost)	Select saw blade with higher lateral tooth projection
	Resin/chips on the flanges	Clean flanges
	Flange run out tolerance too high	Check and correct flange
	Defective motor spindle bearing	Replace motor spindle bearing
	Tooth pitch and gullet too small	Select saw blade with higher tooth pitch
	Unbalanced saw blade	Balance saw blade
	Blunt cutting edges	Resharpen saw blade
	Wrong saw blade tensioning	Correct saw blade tensioning
Wavy cut	Irregular tooth pitch or one sided cut	Correct sharpening machine adjustment, resharpen saw blade
	Irregular tooth thickness	Check and correct saw blade kerf
	Saw blade is blunt, resin build up	Clean and resharpen saw blade
	Position of fence not parallel to feed direction	Check and adjust position
	One sided load from edge cutting	Use edging saw blade (hogger)
	Cutting speed too low	Select larger saw blade diameter or increase RPM
	Wrong saw blade tensioning	Correct saw blade with larger gullet
Jamming of saw blade when cutting	Slot in saw bed is too thin, insufficient chip outflow	Replace/widen saw bed
	Riving knife width is too thin	Replace riving knife
	Gullet too small	Choose saw blade with larger gullet
Curved cut when double edging	Saw blade's sharpening is one sided	Resharpen kerf of saw blade
	Resin and glue on rollers	Clean and resharpen rollers
	Differences in wood thickness	Improvements necessary at customer
	Too high cutting forces on one side	Optimize cutting force division
	Worn conveyor belt guide	Check and adjust chain guide
	Short and uneven workpieces	Comply with minimum workpiece length required by the machine manufacturer's instructions
	When machining piece by piece	Pay attention to angular cut off work pieces
Exceeded tolerances of horizontally cut lamellas	Sawblade tensioning not suitable for horizontal application	Check saw blade tensioning
	High resin build up on saw blade body, it runs very hot from friction in cut	Clean saw blade and check if blunt
	Thickness and position of riving knife not adjusted to dimensions of strips and saw blade kerf	Use riving knife dimension matching saw blade kerf. Adjust riving knife spacing to correspond to thickness of strips
Tear outs in workpieces coated on both sides when machining without scoring saw	Saw blade projection over workpiece too small or too big	Check and adjust saw blade protection
	Tooth shape or number of teeth not suitable for the application	Select saw blade suitable for the application
	Concentric running tolerances of saw blade too high	Have saw blade checked by PILANA service
	Flange used on machine does not correspond to guidelines for flange diameter and concentric running tolerances	Check flanges and clean them. If there is wrong ratio of saw blade diameter to flange diameter, adjust accordingly
Tear outs on panel coating when cutting in stacks	Tool is blunt	Resharpen main saw blade
	Pressure beam cannot press evenly on uneven workpieces	Check pressing forces of pressure beam
Tear outs where tool leaves workpiece when cutting in stacks	Kerf of scoring saw blade is too small for main saw blade in use	Adjust kerf of scoring saw blade to main saw blade accordingly

Symbol Index



tooth pitch



euro pinholes



low noise slots



low noise slots



type of grade



type of grade



type of grade



side balance



side balance

pilana.com



pilanawood.com

Primary Wood Processing



LINCK Machines

- » designed for Linck machines in automated lines for primary wood processing
- » made to fit customer's requirements
- » table below contains only examples of saw blades we produce

D	S	s	d	z	teeth	●/○
390	3,8	2,4	140	24 + 4	FZ	○
440	4,6	3,2	150	28 + 4	FZ	○
460	4,4	2,8	150	24 + 4	FZ	○
460	4,0	2,6	150	28 + 4	FZ	○
490	5,6	4,0	150	36 + 6	FZ	○
505	5,2	3,8 - 6,8	120	28 + 4	FZ L+P	○
535	4,2	2,8	120	40 + 4	FZ	○
540	3,6	2,7 - 5,7	150	30 + 6	FZ L+P	○
540	3,8	2,6	150	36 + 6	FZ	○
630	5,2	3,8 - 4,5	150	24 + 6	FZ L+P	○
630	5,2	3,8 - 7,0	150	24 + 6	FZ L+P	○

ARI VISLANDA, USNR/SCHURMAN, SÖDERHAMN ERIKSSON

- » designed for automated lines for primary wood processing
- » made to fit customer's requirements
- » table below contains only examples of saw blades we produce

D	S	s	d	z	teeth	●/○
500	5,0	3,5	spl*	60	WZ	○
600	4,4	3,2	spl*	48	FZ	○
610	4,2	2,8	spl*	40	FZ	○
640	3,4	2,6	spl*	20	FZ	○
700	4,2	2,8	spl*	42	FZ	○
710	4,2	2,8	spl*	56	FZ	○
1000	4,8	3,6	spl*	60	FZ	○

* spline bore

HEINOLA Machines

- » designed for Heinola machines in automated lines for primary wood processing
- » made to fit customer's requirements
- » table below contains only examples of saw blades we produce

D	S	s	d	z	teeth	●/○
556	4,2	2,8	160	32 + 4	FZ	○
556	4,6	3,2	160	32 + 4	FZ	○
556	4,6	3,2	160	33 + 6	FZ	○
600	4,6	3,2	200	42 + 6	FZ	○

In case that you did not find the type of saw blades you require in our catalogue, please contact us. We will make them upon your specification.



HEW SAW Machines

- » designed for Hew Saw machines in automated lines for primary wood processing
- » made to fit customer's requirements
- » table below contains only examples of saw blades we produce

Pre-saw Blades

D	S	s	d	z	teeth	●/○
345	4,1	3,1 - 10,7	144	36	FZ L+P	○
345	6,4	5,0 - 10,7	144	36	FZ L+P	○
390	4,5	3,7 - 8,7	190	39	FZ L+P	○
460	4,5	3,3 - 8,7	240	42	FZ L+P	○

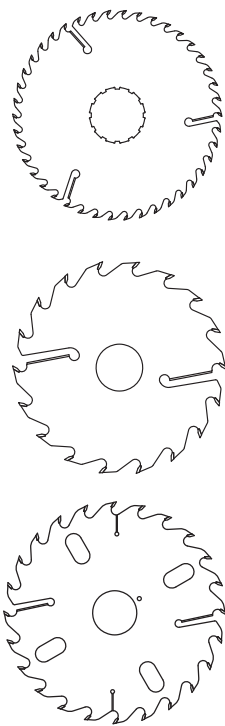

Rip Saw Blades

D	S	s	d	z	teeth	●/○
251	4,0	2,8	55	18 + 2	FZ	○
351	3,4	2,2	70	24 + 2	FZ	○
351	3,2	2,0	70	30 + 3	FZ	○
401	4,0	2,8	100	42 + 3	TFZ	○
450	4,2	3,0	99	24 + 4	FZ	○
500	4,5	3,2	99	32 + 6	FZ	○

Edging Saw Blades

Norm	D	S	s	d	z	teeth
81	350	5	3,6	150	36	FZ (WZ)
81	350	5	3,6	150	56	FZ (WZ)
94.1	400	5,2	3,8	146	40+4	FZ (WZ)
94.1	400	5	3,6	146	46+4	FZ (WZ)
94.2	400	5,5	4	146	50+4	FZ (WZ)

We produce circular saw blades for machines of all established wood-processing machine manufacturers.

In case that you did not find the type of saw blades you require in our catalogue, please contact us. We will make them upon your specification.

Material: Natural solid – soft and hard wood
Application: Multirip sawing of massive natural woods
Machine: Multirip saw, for single shaft, double shaft and splitting machine

94 FZ +2



- » universal rip saw blades for longitudinal cutting of all types of wood, dry and wet, with standard quality cutting edge and lower height of the cut
- » application: for multirip machines for primary processing of wood and pallet production

D	S	s	d	z	h _{max}	d _{p max}	●/○	Bore	C1xA1	C2xA2
180	2,6	1,6	30	16+2	40	60	○	70	13x80	20x83
200	2,8	1,8	30	16+2	40	100	○	75	14x85	22x90
250	3,6	2,5	70,80	16+2	50	130	●	80	14x90	22x93
300	4,0	2,8	70,80	18+2	70	130	●			
315	4,0	2,8	80	18+2	70	150	●			
350	4,0	2,8	70,75,80	20+2	75	180	●			
400	4,0	2,8	80	24+2	80	210	●			

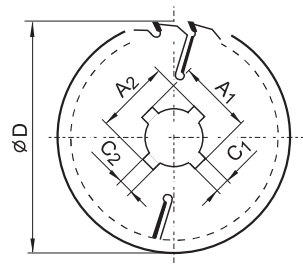

94.1 FZ +2+2



- » universal rip saw blades for longitudinal cutting of all types of wood, dry and wet, with standard quality cutting edge and lower height of the cut
- » application: for multirip machines for primary processing of wood and pallet production

D	S	s	d	z	h _{max}	d _{p max}	●/○	Bore	C1xA1	C2xA2
250	3,2	2,2	70,80	16+2+2	60	105	●	70	13x80	20x83
300	3,2	2,2	70,80	18+2+2	80	120	●	75	14x85	22x90
300	3,2	2,2	30	24+2+2	80	120	●	80	14x90	22x93
315	3,2	2,2	70,80	18+2+2	85	120	●			
350	3,6	2,5	70,75,80	20+2+2	105	120	●			
350	3,6	2,5	30	24+2+2	105	120	●			
400	4,0	2,8	30	18+2+2	120	145	●			
400	4,0	2,8	70,80	24+2+2	120	145	●			
450	4,4	3,2	30	20+2+2	135	160	●			
450	4,4	3,2	70,80	28+2+2	135	160	●			
500	4,4	3,2	30	22+2+2	150	180	●			
500	4,4	3,2	70	28+2+2	150	180	●			

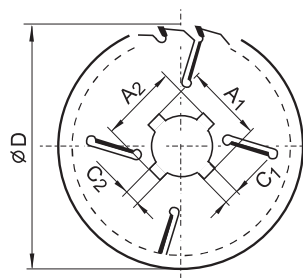

The central bore of all saw blades can be enlarged up to: $d_{max} = d_{p max} - 30 \text{ mm}$

D – blade diameter [mm], S – tooth width [mm], s – body thickness [mm], d – bore [mm], z – number of teeth, h_{max} – maximum cut height [mm], d_{p max} – max. flange diameter [mm], d_{max} – max. rebore diameter [mm], ● – in stock, ○ – made to customer's request

In case that you did not find the type of saw blades you require in our catalogue, please contact us. We will make them upon your specification.

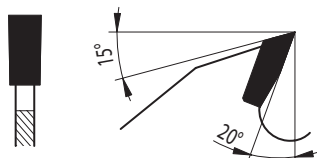

94.1 FZ +2+2+2



- » universal rip saw blades for longitudinal cutting of all types of wood, dry and wet, with a standard quality of the cutting edge
- » 6 wiper slots enable excellent saw stability even when cutting very long round pieces of wood or prisms
- » application: for multirip machines for primary processing of wood and pallet production

D	S	s	d	z	h _{max}	d _{p max}	●/○
400	4,0	2,8	30	24+2+2+2	130	125	●
400	4,0	2,8	30	28+2+2+2	130	125	○
450	4,4	3,2	30	20+2+2+2	150	130	●
500	4,4	3,2	30	22+2+2+2	175	130	●
550	5,0	3,5	30	24+2+2+2	195	150	●
550	5,0	3,5	30	32+2+2+2	195	150	●
600	5,0	3,5	30	26+2+2+2	205	170	●

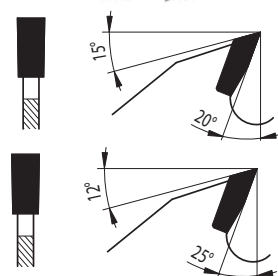
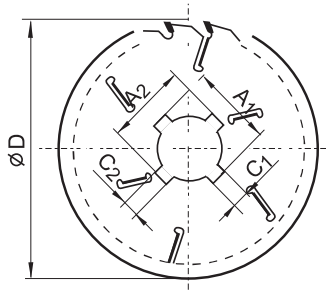

94.1 FZ – MASSIVE



- » extra strong multirip saw blades for longitudinal cutting of all types of wood, dry and wet, with a standard quality of the cutting edge. Designed for extreme cutting conditions thanks to the very stable and massive saw body which eliminates side strain and ensures stability of the saw blade

D	S	s	d	z	h _{max}	d _{p max}	●/○	Bore	C1xA1	C2xA2
315	4,0	2,8	70,80	18+2+2	90	120	●	70	13x80	20x83
350	4,0	2,8	70,75,80	20+2+2	105	120	●	75	14x85	22x90
400	4,2	3,0	30	20+2+2	120	145	●	80	14x90	22x93
450	5,0	3,5	30	20+2+2	135	160	●			
500	5,0	3,5	30	22+2+2+2	175	130	●			
550	5,5	3,5	30	24+2+2+2	190	150	●			

D	S	s	d	z	h _{max}	d _{p max}	●/○
600	6,2	4,0	30	26+2+2+2	205	170	●
700	6,5	4,5	30	28+2+2+2	235	210	●
800	7,5	5,0	30	24+2+2+2+2	300	170	●

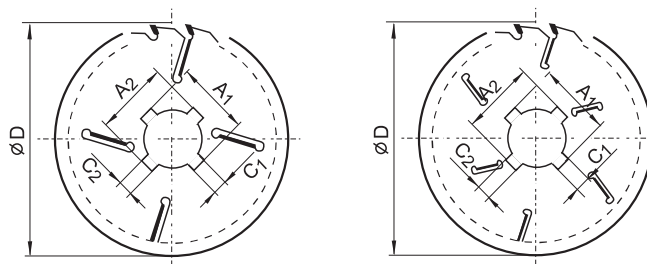

In case that you did not find the type of saw blades you require in our catalogue, please contact us. We will make them upon your specification.

The central bore of all saw blades can be enlarged up to: $d_{max} = d_{p max} - 30 \text{ mm}$

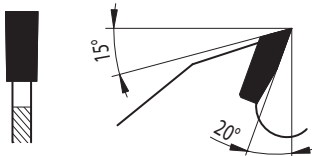

94.1 FZ – MASSIVE plus



» extra strong multirip saw blades for longitudinal cutting of all types of wood, dry and wet, with a standard quality of the cutting edge. Designed for extreme cutting conditions thanks to a very stable and massive saw body which eliminates side strain and ensures stability of the saw blade

D	S	s	d	z	h _{max}	d _{p max}	●/○
300	5,0	3,5	30	18+2+2	90	105	●
320	5,0	3,5	30	18+2+2	100	105	●
350	5,0	3,5	30	18+2+2	110	105	○
400	5,0	3,5	30	20+2+2	120	145	○
450	5,5	3,5	30	20+2+2	145	140	○

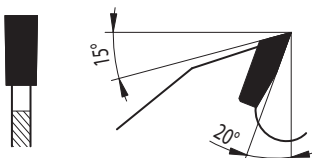

94.1 FZ – TOS, RAIMANN, COSTA



» specially constructed multirip saw blades for longitudinal cutting of all types of wood, dry and wet, with a standard quality of the cutting edge for multirip machines by TOS SVITAVY

» possibility to rip wood up to the clamping flange of the saw blade without losing body stability of the saw blade with a large side strain and thus ensuring maximum utilisation of the machine. With spiral design of the keyways, it also offers the possibility of a smoother entering into the cut

D	S	s	d	z	h _{max}	d _{p max}	●/○	Bore	4x C1x A1
300	3,2	2,2	80	18+2+2	90	105	●	80	13x90
320	3,2	2,2	80	18+2+2	100	105	●		
350	4,0	2,8	80	18+2+2	115	105	●		
400	4,0	2,8	80	20+2+2	140	105	●		
450	4,4	3,2	80	24+2+2	165	105	●		

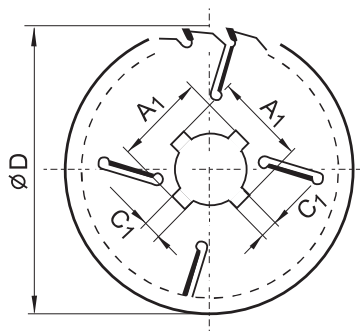

In case that you did not find the type of saw blades you require in our catalogue, please contact us. We will make them upon your specification.

The central bore of all saw blades can be enlarged up to: $d_{max} = d_{p max} - 30 \text{ mm}$

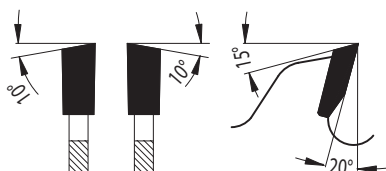

94.1 WZ – TOS, RAIMANN, COSTA



- » specially designed multirip saw blades for longitudinal cutting of all types of wood, dry and wet
- » possibility to rip wood up to the maximum bore of the saw blade without losing body stability of the saw blade with a large side strain. Thereby the maximum utilisation of the machine is ensured
- » with its design of the wiper slots, it also offers the possibility of a smoother entering into the cut
- » WZ geometry ensures a smooth, stable cut with a superior quality of the cutting edge and electric energy savings
- » It is suitable to use in higher quality type of wood

D	S	s	d	z	h _{max}	d _{p max}	●/○	Bore	4x C1xA1
300	3,2	2,2	30	18+2+2	90	105	●	80	13x90
320	3,2	2,2	30	18+2+2	100	105	●		
350	3,6	2,5	30, 80	18+2+2	115	105	●		
400	3,6	2,5	30	20+2+2	140	105	●		
450	4,0	2,8	30	24+2+2	165	105	●		

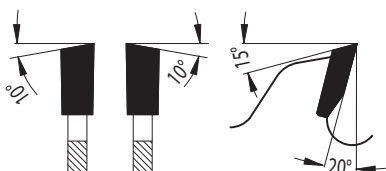

94.1 WZ



- » universal rip saw blades for longitudinal cutting of all types of wood, dry and wet, with a standard quality of the cutting edge
- » WZ geometry ensures fluent and stable cut with high quality cutting edge and energy savings
- » used in multirip saw machines for primary wood processing and production of palets
- » suitable for mounting on bottom shaft of multirip saw machine

D	S	s	d	z	h _{max}	d _{p max}	●/○
300	3,2	2,2	30	24+2+2	80	120	○
350	4,0	2,8	30	24+2+2	105	120	○
400	4,0	2,8	30	28+2+2+2	130	125	○

In case that you did not find the type of saw blades you require in our catalogue, please contact us. We will make them upon your specification.

The central bore of all saw blades can be enlarged up to: $d_{max} = d_{p max} - 30 \text{ mm}$

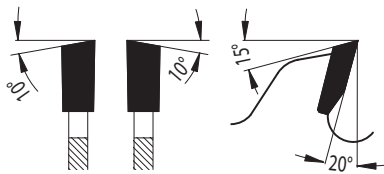

94.1 WZ – EFFECTIVE



- » thin multirip saw blades for longitudinal cutting of all types of wood, especially planks and stronger boards. Decrease in weight will positively show in energy savings and increased yield
- » WZ tooth geometry ensures a smooth, stable cut with a superior quality of the cutting edge, it is suitable for use in higher quality type of wood
- » application: for multirip machines

D	S	s	d	z	h _{max}	d _{p max}	●/○
250	2,7	1,8	30	20+2+2	65	110	●
300	2,7	1,8	30	24+2+2	80	120	●
350	3,5	2,5	30	24+2+2+2	105	120	●

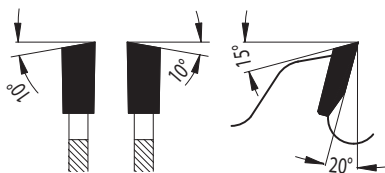

94.1 Angle Tilting Saws



- » specially designed rip saw blades for angle tilting saws
- » the number of teeth is calculated for the maximum cutting height
- » clearance teeth exactly match the flange of individual machine types which eliminates cracking of saw blades while ensuring maximum amount of chip removal from the cut
- » the reinforcement and thermal treatment of the saw blades ensures their perfect action in the horizontal cut conditions
- » the tooth geometry is optimised for maximum cutting speed of the saw blades

STROJCAD - WZ

D	S	s	d	z	h _{max}	●/○
400	4,2	3,0	30 + 6/17/96	20+2+2	120	●
400	4,2	3,0	55 + 6/17/112	20+2+2	120	●
450	5,0	3,5	55 + 6/17/112	20+2+2	145	●
500	5,2	3,5	30 + 6/17/96	22+2+2+2	170	●
500	5,2	3,5	55 + 6/17/112	22+2+2+2	170	●
550	5,5	3,5	30 + 6/17/96	24+2+2+2	205	●
550	5,5	3,5	55 + 6/17/112	24+2+2+2	195	●

WEP - FZ

D	S	s	d	z	h _{max}	●/○
500	5,0	3,5	30+8/11/100+2/10/60	22+2+2+2	155	●
500	5,0	3,5	30+8/11/150+2/10/60	22+2+2+2	155	●
550	5,5	3,5	30+8/11/100+2/10/60	24+2+2+2	180	●
550	5,5	3,5	30+8/11/150+2/10/60	24+2+2+2	180	●

In case that you did not find the type of saw blades you require in our catalogue, please contact us. We will make them upon your specification.

We can produce in dimensions from $\varnothing 150$ to $\varnothing 1000$.

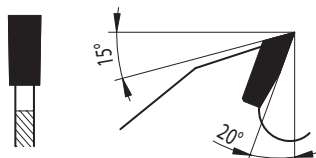

94.2 LFZ



- » longitudinal cutting of soft and hard woods
- » trimming saw, multitrip saw, joining saw
- » saw blade geometry includes a chip thickness limiter

D	B	b	d	z	h _{max}	d _{p max}	●/○
250	3,2	2,2	30	18+3	55	115	●
300	3,2	2,2	30	18+3	75	130	●
350	3,6	2,5	30	20+2+2	110	110	●
400	4,0	2,8	30	24+2+2	125	120	●

94.3 Saw Blade with Reinforced Centre



94.4 Tempered Unpolished Body with Intermediate Tooth



Heat and Surface Treatment of Saw Blades

Special tempering:

- » thermal treatment of saw blades made on customer's request
- » prevents the occurrence of cracks and tears in the body of the saw blade especially in hard cutting conditions
- » increases the lifespan of the saw blade

Black coating:

- » increases the saw blade lifespan by up to 20% compared to untreated TCT saw blade
- » treatment of saw blades is made on customer's request
- » thin chemical layer of black colour on the saw blade surface made by oxidizing

Material: Solid natural wood
Application: Cutting of woods of massive dimensions
Machine: Machine feed

33.1 FZ



- » along the grain cutting of massive wood dimensions
- » machine feed

D	S	s	d	z	●/○
600	5,5	3,5	30	40	●
700	5,5	3,5	35	40	●
800	6,5	4,5	35	40	●

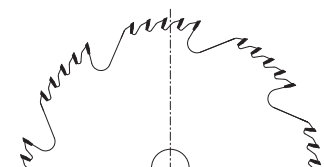
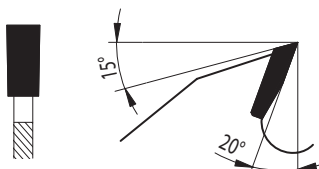

LUCAS or ECOPRO



- » along the grain cutting of massive wood dimensions
- » suitable for manual and automatic feed

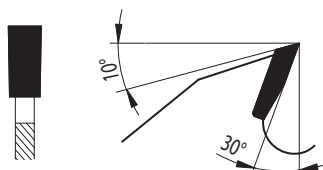

D	S	s	d	z	teeth	●/○
542	6,0	3,5	30	5, 8, 10	LFZ	○
634	6,0	3,6 or 4,0	30	5, 8, 10	LFZ	○





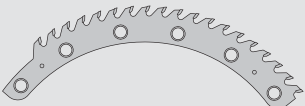
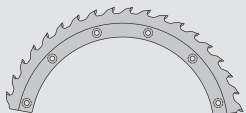
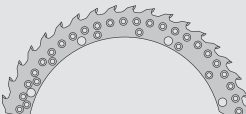
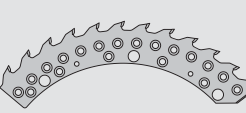
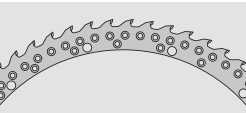
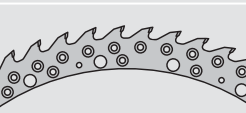
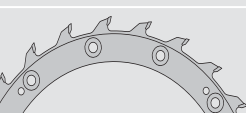
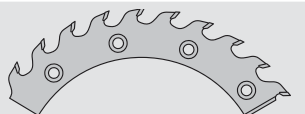
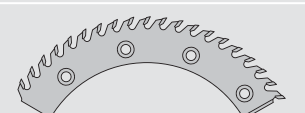
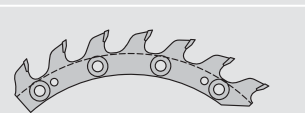
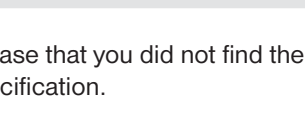
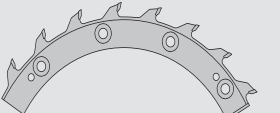
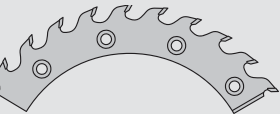

In case that you did not find the type of saw blades you require in our catalogue, please contact us. We will make them upon your specification.

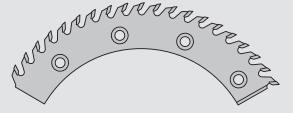
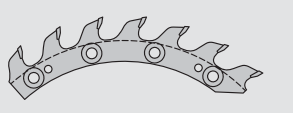
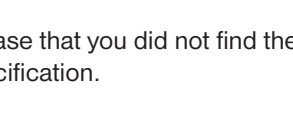
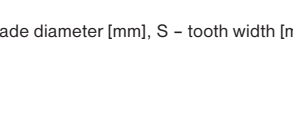

» designed for Linck, EWD and other machines in automated lines for primary wood processing

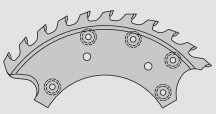
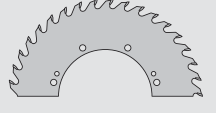
	Machine type	D	S	s	z	●/○
	EWD-FZ 3	555	6,2	5	19	○
	V25	570	4,5	3,5-5,0	19	○
		570	4,5	3,5-5,0	19	○
		570	4,5	3,5	19	○
		570	4,5	3,5	19	○
		570	4,5	3,5	12	○
		570	4,5	3,5	12	○
	V40	830	4,5	3,5	17	○
		830	4,5	3,5	17	○
		830	5	4	12	○
		830	5	4	12	○
	VP34	403	3,5	2,5-5,0	8	○
		403	3,5	2,5-5,0	8	○
	VP48	411	6,4	4,9	10	○
		411	6,4	4,9	10	○
		411	6,4	4,9	20	○
		411	6,4	4,9	20	○
		411	4	3,0-5,0	7	○
		411	4	3,0-5,0	7	○

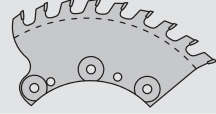
In case that you did not find the type of segments you require in our catalogue, please contact us. We will make them upon your specification.

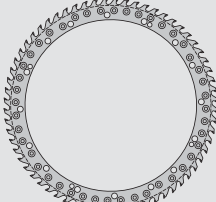
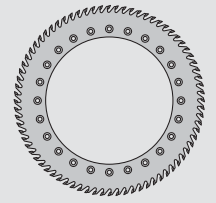
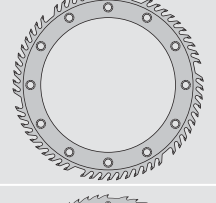
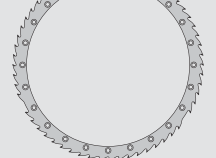
	machine type	D	S	s	z	●/○
	VP48	415	3,5	2,5-8,0	11	○
		415	3,5	2,5-8,0	11	○
		415	6	5	19	○
		415	8	7	15	○
  	VPS	400	3,5	2,5-8,0	9	○
		400	3,5	2,5-8,0	9	○
		401	3,5	2,5-8,0	10	○
		401	3,5	2,5-8,0	10	○
		401	4,5	3,5-8,0	10	○
		401	4,5	3,5-8,0	10	○
		497	3,5	2,5-8,0	8	○
		497	3,5	2,5-8,0	8	○
		497	3,5	2,5-8,0	8	○
	VM30	730	4,5	3,5-6,0	64	○
		730	4,5	3,5-6,0	64	○
		530	6,4	5	76	○
		650	6,5	4,5-7,0	60	○
		650	6,5	4,5-7,0	60	○
			830	6,5	5	57

In case that you did not find the type of segments you require in our catalogue, please contact us. We will make them upon your specification.

We produce circular saw blades for machines of all established wood - processing machine manufacturers.

pilana.com



pilana.wood.com

Secondary Wood Processing



Material: Natural wood – soft, hard, wet or dry
Application: Cutting and ripping along and across the grain of natural solid wood

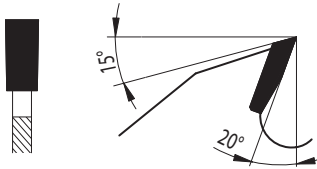

80-50 FZ

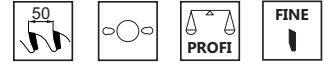

- » cutting along the grain of natural solid wood
- » suitable for prismatic beam saws

D	S	s	d	z	●/○
300	4,0	2,8	30	18	●
350	4,0	2,8	30	20	●
400	4,4	3,2	30	24	●
450	4,4	3,2	30	28	●
500	5,2	3,5	30	30	●
550	5,5	3,5	30	32	●
600	5,5	3,5	30	36	●

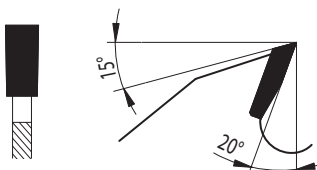

80-40 FZ



- » cutting along the grain of natural solid wood

D	S	s	d	z	●/○
200	2,5	1,6	20	16	●
250	3,2	2,2	30	20	●
300	3,2	2,2	30	24	●
350	3,6	2,5	30	28	●
400	3,6	2,5	30	32	●
450	4,0	2,8	30	36	●
500	4,0	2,8	30	40	●
600	5,5	3,5	30	48	●
700	5,5	3,5	35	56	●

In case that you did not find the type of saw blades you require in our catalogue, please contact us. We will make them upon your specification.

81-26 WZ

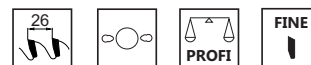

- » universal cutting along and across the grain of natural solid wood
- » cutting of plywood, unprocessed chipboard and wood based panels

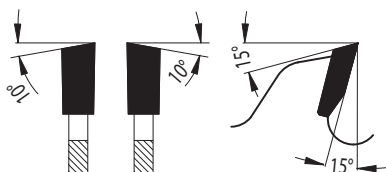

D	S	s	d	z	●/○
160	2,5	1,6	20	16	●
180	2,5	1,6	20	20	●
200	2,5	1,6	20	24	●
250	3,2	2,2	30	32	●
300	3,2	2,2	30	36	●
350	3,6	2,5	30	40	●
400	3,6	2,5	30	48	●
450	4,0	2,8	30	56	●
500	4,0	2,8	30	64	●
550	5,2	3,5	30	64	●
600	6,0	4,0	30	64	●

81-20 WZ



- » cutting across the grain of natural wood
- » cutting of plywood, unprocessed chipboard and wood based panels

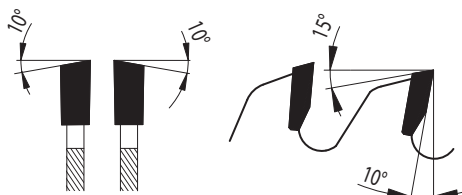

D	S	s	d	z	●/○
160	2,5	1,6	20	24	●
180	2,5	1,6	20	28	●
200	2,5	1,6	20	32	●
250	3,2	2,2	30	40	●
300	3,2	2,2	30	48	●
315	3,2	2,2	30	48	●
350	3,6	2,5	30	54	●
400	3,6	2,5	30	64	●
450	4,0	2,8	30	72	●
500	4,0	2,8	30	84	●
500	4,2	3,0	30	84	●
550	5,2	3,8	30	84	●
600	5,2	3,5	30	90	●
650	5,9	4,2	30	100	●

In case that you did not find the type of saw blades you require in our catalogue, please contact us. We will make them upon your specification.

81-16 WZ



- » cutting across the grain of natural wood
- » cutting of plywood, unprocessed chipboard, wood based panels and exotic solid woods

D	S	s	d	z	●/○
180	2,5	1,6	20	36	●
200	2,5	1,6	20	40	●
250	3,2	2,2	30	48	●
300	3,2	2,2	30	60	●
300	3,2	2,2	30	64	●
350	3,6	2,5	30	72	●
400	3,6	2,5	30	84	●
450	4,2	3,0	30	84	●
500	4,0	2,8	30	100	●
550	5,0	3,8	30	96	●
600	5,7	4,0	30	110	●

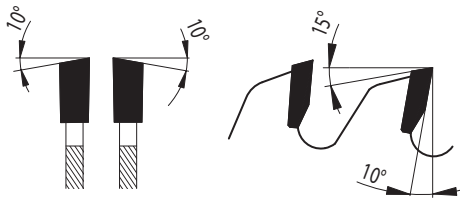

81-13 WZ



- » cutting across the grain of natural wood
- » cutting of plywood, veneer, unprocessed chipboard, wood based panels and exotic solid woods

D	S	s	d	z	●/○
160	2,5	1,6	20	36	●
200	2,5	1,6	20	48	●
250	3,2	2,2	30	60	●
250	3,2	2,2	30	64	●
300	3,2	2,2	30	72	●
350	3,6	2,5	30	84	●
400	3,6	2,5	30	96	●
400	3,8	2,8	30	96	●
450	5,0	3,2	30	108	●
500	5,0	3,2	30	120	●

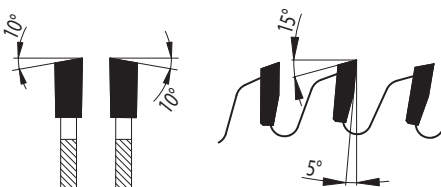

In case that you did not find the type of saw blades you require in our catalogue, please contact us. We will make them upon your specification.

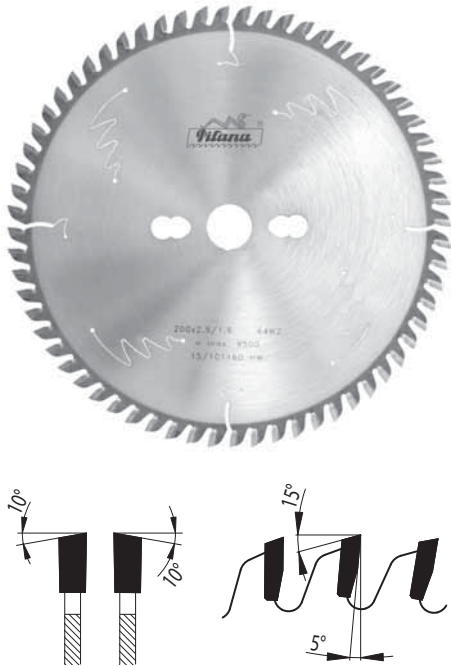

81-11 WZ



- » high quality smooth cutting across the grain of natural wood
- » cutting of plywood, veneer, unprocessed chipboard, wood based panels and exotic solid woods

D	S	s	d	z	●/○
160	2,5	1,6	20	48	●
180	2,5	1,6	20	56	●
200	2,5	1,6	20	64	●
250	3,2	2,2	30	72	●
250	3,2	2,2	30	80	●
300	3,2	2,2	30	96	●
350	3,6	2,5	30	108	●
400	3,6	2,5	30	120	●
400	3,8	2,8	30	108	●
450	4,2	3,0	30	120	●
500	4,0	2,8	30	144	●



83-35 LWZ



- » cutting along and across the grain of natural solid wood
- » saw blade geometry includes a chip thickness limiter
- » anti-kick back design

D	S	s	d	z	●/○
250	3,2	2,2	30	24	●
300	3,2	2,2	30	28	●
315	3,2	2,2	30	28	●
350	3,6	2,5	30	32	●
400	3,6	2,5	30	36	●
450	4,0	2,8	30	40	●
500	4,0	2,8	30	44	●
600	5,2	3,5	30	54	●

In case that you did not find the type of saw blades you require in our catalogue, please contact us. We will make them upon your specification.

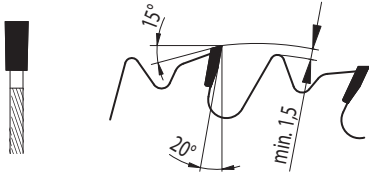

83-55 LFZ

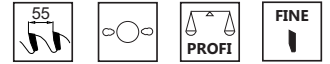

- » cutting along the grain of natural solid wood
- » suitable for single blade machines with manual feed
- » saw blade geometry includes a chip thickness limiter
- » anti-kick back design

D	S	s	d	z	●/○
300	3,6	2,5	30	18	●
350	4,0	2,8	30	20	●
400	4,0	2,8	30	24	●
500	4,0	2,8	30	36	●
600	4,2	2,8	30	36	●
700	4,4	3,2	30	44	●



81 WZ Saw Blades for Fire Wood

- » cross cutting of natural solid wood
- » suitable for cutting of fire wood



D	S	s	d	z	teeth	●/○
600	4,0	2,8	30	40	LWZ	●
700	4,2	3,2	30	42	LFZ	●
700	4,2	3,2	30	84	WZ	●
700	5,0	3,8	30	60	WZ	○

WZ



LWZ

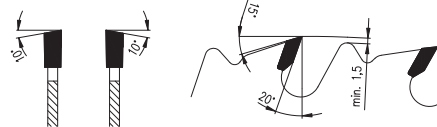

LFZ

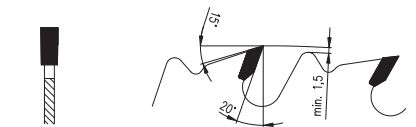

In case that you did not find the type of saw blades you require in our catalogue, please contact us. We will make them upon your specification.

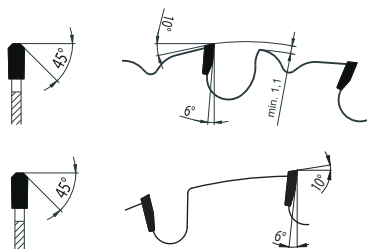

88 TZ GLADIUS



- » cutting of construction wood containing metal parts, chipboard, Heraklit boards, porous concrete
- » tooth geometry improves resistance against abrasive and mechanical damage

D	S	s	d	z	●/○
300	3,2	2,2	30	20	●
350	3,6	2,5	30	24	●
400	3,6	2,5	30	28	●
450	4,0	2,8	30	32	●
500	4,0	2,8	30	36	●
600	3,8	2,8	30	42	●
700	4,2	3,2	30	48	●

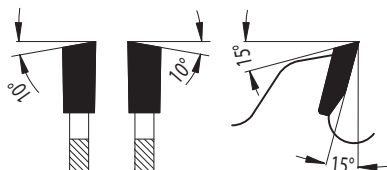

TCT Circular Saw Blades for Pruning

- » suitable for use in hard shoulder rotary trimmers
- » for clearing of vegetation from road shoulders on Mulag® and similar machines



D	S	s	d	z	●/○
390	3,5	2,5	25	60	○
390	3,5	2,5	61	60	○
500	4,0	3,0	30	60	○
500	4,0	3,0	30	72	○
590	4,5	3,6	30	78	○
590	4,5	3,6	85	78	○
600	4,0	3,0	45	60	○

In case that you did not find the type of saw blades you require in our catalogue, please contact us. We will make them upon your specification.

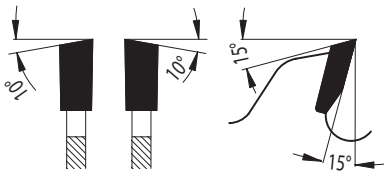

81 WZ – “Hundegger” Type



- » for use in joinery machines (e.g. fully automatic Hundegger or Paul machines) to cut or trim timber, roofing materials, construction panels & boards, logs or beams, wood for lining, planking and other types of wood used in construction
- » cutting across & along the grain, cutting to size or angle cutting of frames in soft and hard wood
- » circular saw blades with positive hook angle, WZ tooth shape and robust body to cope with high mechanical load
- » pinholes are added to a particular saw blade on request based on the type of machine used

D	S	s	d	z	Pin holes	●/○
720	6,0	4,5	30	72	4-8.5-90+2-15-415 8-8.5-120 sunken 4-8,1-90 2-14-400	●
760	6,0	4,5	30	72	4-8.5-90+2-15-415	●
800	6,0	4,5	30	72	"8-8.5-160 sunken 4-8.1-90 2-14-400"	●
800	6,0	4,5	30	80	4-8.5-90+2-15-415	●

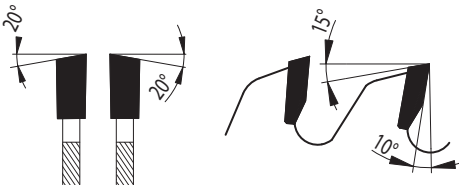

81 WZ OPTI Cross Cut & Cut Off Saw



- » saw blades with suitable tooth geometry for cross cutting and cut off optimising applications
- » for optimising saws made by STÖRI MANTEL, WEINIG, DIMTER, HOLZ-HER, PANHANS and other manufacturers
- » standard bevel angle 20 degrees, possibility to sharpen up to 40 degrees or WZ/SSW on request and under special production

D	S	s	d	z	●/○
400	3,8	2,8	30	60	●
400	4,5	3,2	30	120	●
450	4,8	3,5	30	138	●
500	5	3,2	30	96	●
500	5,2	3,2	30	120	●
500	4,8	3,5	30	144	●
550	4,8	3,5	30	144	●
600	5,8	4	30	120	●
600	5,4	4	30	172	●

In case that you did not find the type of saw blades you require in our catalogue, please contact us. We will make them upon your specification.

Application: Cutting of wood and wood based materials

Machine: Miter saws and optimising saws



81 WZ SSW



- » saw blades designed for all regular types of miter saws
- » featuring alternate face bevel intended for high quality of cutting surface

D	S	s	d	z	●/○
254	2,6	1,6	30	60	○
260	2,6	1,8	30	60	●
305	2,8	1,8	25,4	80	○

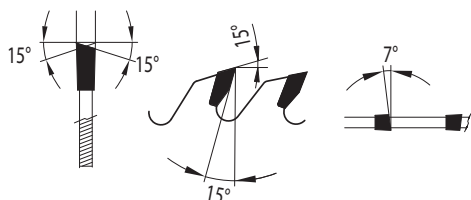

81 WZ N



- » suitable for trimming applications
- » used in pendulum cross cut saws, radial saws with manual feed
- » negative hook angle enables fluent cutting start

D	S	s	d	z	●/○
210	2,6	1,8	30	24	●
210	2,8	1,8	30	48	●
210	2,8	1,8	30	60	●
216	2,8	1,8	30	24	●
216	2,8	1,8	30	48	●
216	2,8	1,8	30	60	●
216	2,8	1,8	30	80	●
250	2,8	1,8	30	48	●
250	2,8	1,8	30	60	●
250	2,8	1,8	30	80	●
260	2,8	1,8	30	60	
260	2,8	1,8	30	80	
305	2,6	1,8	30	60	

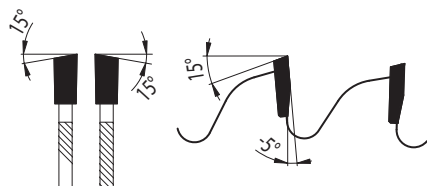

In case that you did not find the type of saw blades you require in our catalogue, please contact us. We will make them upon your specification.

Material: Natural wood
Application: Cutting of wood and wood based materials, grooving
Machine: CNC machines, grooving machines

81 CNC



- » designed for CNC machining centers with circular saw blade attachments
- » suitable for cutting, grooving and formatting
- » precise geometry ensures excellent quality of the edge

WZ/FZ H

D	S	s	d	z	Pinholes	Machine	●/○
100	3,5	2,5	30	35		Weeke	●
100	4,0	2,8	30	35		Weeke	●
120	3,5	2,5	20	35	2x3/4,5 /35	SCM, Morbidelli	●
120	3,5	2,5	35	35	2x4/6,3/50	Biesse	●
120	4,0	2,8	20	35	2x3/4,5/35	SCM, Morbidelli	●
120	4,0	2,8	35	35	2x4/6,3/50	Biesse	●
125	3,5	2,5	30	35	2x4/5,5/48	Homag, Weeke	●
125	4,0	2,8	30	35	2x4/5,5/48	Homag, Weeke	●

WZ/FZ H

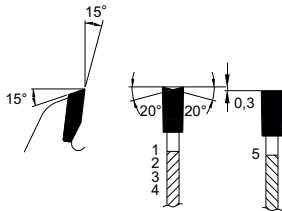

WZF/SSW

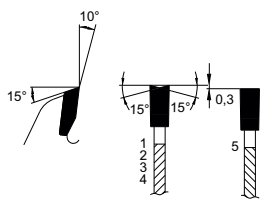

WZF/SSW

D	S	s	d	z	Pinholes	Machine	●/○
300	3,2	2,4	30	100	8/6/90	Homag	●
300	3,2	2,4	30	100	6/6,8/90	universal	●
300	3,2	2,4	50	100	6/5/80	Biesse	●
350	3,5	2,6	30	110	8/6/90	Homag	●
350	3,5	2,6	30	110	6/6,8/90	universal	○

92 FZ



- » grooving of all types of natural wood and furniture materials

D	S	s	d	z	●/○
125	4,0 - 10,0		30	10	○
150	3,0	2,2	30	12	●
150	3,5	2,5	30	12	●
150	4,0	2,5	30	12	●
150	5,0	3,5	30	12	●
150	6,0	3,5	30	12	●
150	8,0 - 12,0		30	12	○
180	4,0	2,5	30	16	●
180	5,0	3,5	30	16	●
180	6,0	3,5	30	16	●
180	8,0 - 12,0		30	16	○
200	4,0	2,5	30	32	●
200	5,0	3,5	30	32	●



In case that you did not find the type of saw blades you require in our catalogue, please contact us. We will make them upon your specification.

TCT Saw Blades for Grooving / TCT Saw Blades for Grooving in Biscuit Joining



Material: Natural wood, chipboard
Application: Grooving



96 WZ



- » size adjustable grooving in combination with a clamping bush
- » saw blades suitable for wobble saws

D	S	s	R _{max}	H _{max}	d	z	●/○
200	3,2	2,2	15	50	50	32	●
250	3,6	2,5	20	70	50	40	●
300	3,6	2,5	22	100	50	48	●

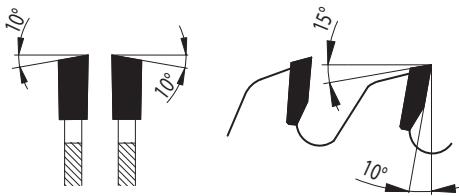

5748 Clamping bushes

- » clamping bush is made of steel, size of required grooves is adjustable by using skew symmetric plates and matrix

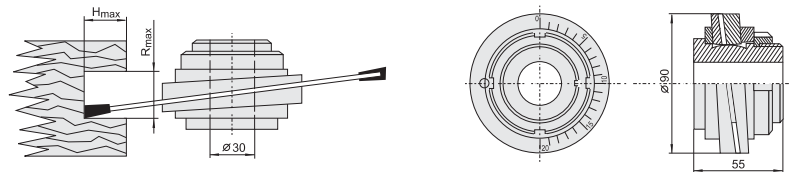

83 LWZ



- » grooving saw blades used in hand machines for making of biscuit joining

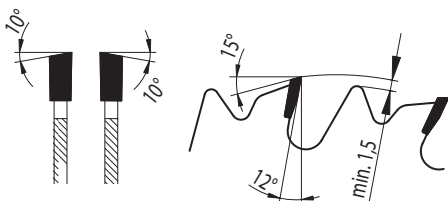

In case that you did not find the type of saw blades you require in our catalogue, please contact us. We will make them upon your specification.

D - blade diameter [mm], S - tooth width [mm], s - body thickness [mm], d - bore [mm], z - number of teeth, R_{max} - maximum groove width [mm], H_{max} - maximum groove depth [mm], ● - in stock, ○ - made to customer's request

Material: Wood and plastics, laminated materials
Application: Sawing with electrical hand-held machines

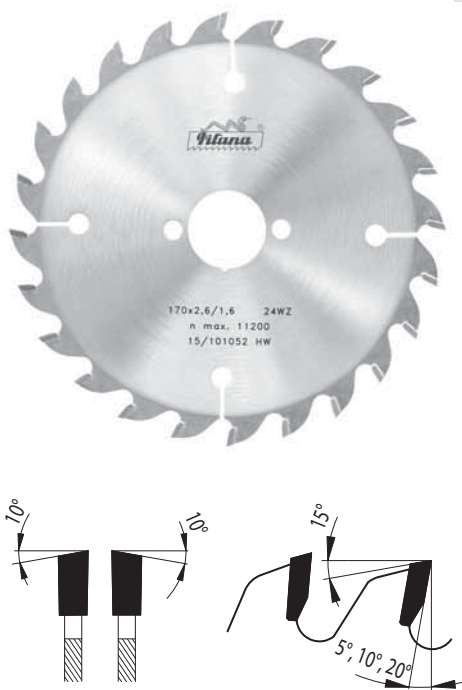

91 WZ



Characteristics:

» cutting wood and plastics with electrical hand-held machines

D	S	s	d	z	●/○
127	2,6	1,6	20	10, 20, 36	●
130	2,6	1,6	20	10, 20, 36	●
140	2,6	1,6	20	10, 20, 42	●
150	2,6	1,6	20	12, 24, 40, 48	●
160	2,2	1,6	20	24, 48	●
160	2,6	1,6	20	12, 24, 40, 48	●
165	2,2	1,6	20	20, 24, 48, 56	●
170	2,6	1,6	30	12, 24, 40, 54	●
180	2,6	1,6	30	12, 24, 40, 56	●
184	2,6	1,6	30	12, 24, 40, 56	●
190	2,2	1,6	20	20, 24, 48, 56	●
190	2,6	1,6	30	14, 24, 30, 40, 56	●
200	2,8	1,8	30	16, 30, 40, 64	●
210	2,8	1,8	30	18, 32, 40, 64	●
216	2,8	1,8	30	24, 48, 64	●
230	2,8	1,8	30	20, 34, 48, 64	●
235	2,8	1,8	30	20, 24, 34, 48, 64	●

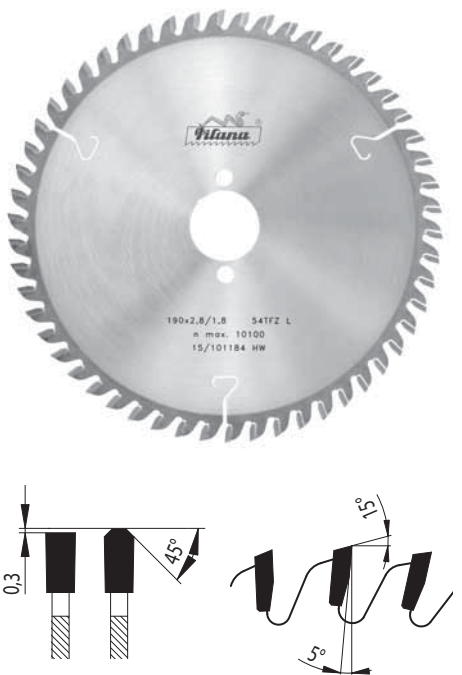

91 TFZ L



Characteristics:

» geometry suitable for cutting of laminated materials

D	S	s	d	z	●/○
160	2,2	1,6	20	24, 48	●
160	2,8	1,8	20	48	●
190	2,8	1,8	30	54	●

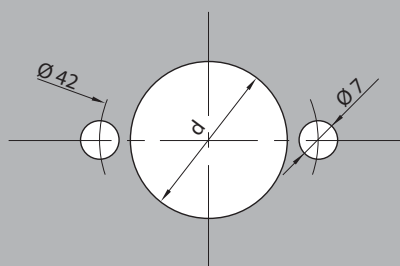

All TCT saw blades for electrical hand-held machines include pinholes shown on the left.

In case that you did not find the type of saw blades you require in our catalogue, please contact us. We will make them upon your specification.

pilana.com



pilanawood.com

TCT Sizing Saw Blades



Material: Laminated chipboard, MDF and HDF

Application: Cutting of laminated boards

Machine: Panel sizing machines

HIGH PROFI+



- » Pilana's premium line of saw blades for cutting of laminated chipboards, MDF and HDF featuring larger TCT tips that allow for more resharpening
- » low noise slots for additional silencing of the saw blade
- » supplied in TFZ, TZ/TZ and WZ L geometry
- » for optimal cutting the use of a scoring blade is recommended

97 TFZ L HP+

D	S	s	d	z	●/○
300	4,4	3,2	30, 60	72	●
320	4,4	3,2	30	60	●
350	4,4	3,2	30, 60	72	●
360	4,4	3,2	30, 65	72	●
380	4,4	3,2	30	72	●
380	4,8	3,5	30	72	●
400	4,4	3,2	30	72	●
450	4,4	3,2	30	72	●

97 TZ/TZ L HP+

D	S	s	d	z	●/○
350	4,4	3,2	30	72	●

98 WZ L HP+

D	S	s	d	z	●/○
350	4,4	3,2	30	54	●

97 TFZ L HP



- » designed for cutting of chipboard based materials, MDF and HDF
- » in combination with a conical scoring saw blade for achieving of excellent cutting performance (KON or KON/WZ based on customer's request)
- » long lifespan of carbide tips

D	S	s	d	z	●/○
300	4,4	3,2	30	60	●
350	4,4	3,2	30	72	●
380	4,4	3,2	30	72	●
400	4,4	3,2	30	72	●
450	4,4	3,2	30	72	●

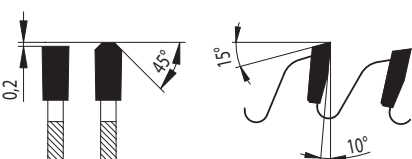
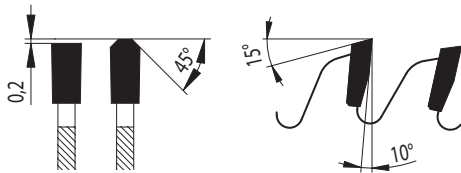

In case that you did not find the type of saw blades you require in our catalogue, please contact us. We will make them upon your specification.



93 KON WZ HP+



» scoring saw blades for equipment with the possibility of height adjustment of the scoring saw blade accessory

D	S	s	d	z	●/○
125	4,4 - 5,2	3,2	20	24	●
150	4,4 - 5,2	3,2	20	24	●
160	4,4 - 5,2	3,2	55	36	●
180	4,4 - 5,2	3,5	30, 45	36	●
200	4,4 - 5,2	3,5	20	36	●
200	4,8 - 5,6	3,5	45	36	●

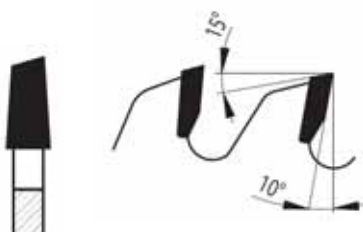

93 KON FZ



» scoring saw blades for equipment with the possibility of height adjustment of the scoring saw blade accessory

D	S	s	d	z	●/○
125	4,3 - 5,4	3,0	20	24	●
150	4,4 - 5,6	3,2	45	24	●
180	4,8 - 5,8	3,5	45	36	●
200	4,3 - 5,1	3,5	20	34	●

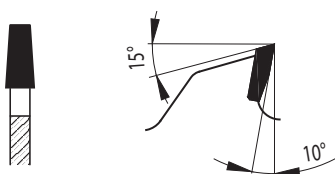

In case that you did not find the type of saw blades you require in our catalogue, please contact us. We will make them upon your specification.

Material: Laminated chipboard, MDF and HDF
Application: Cutting of laminated boards
Machine: Sizing machines

97 TFZ L HP+



- » Pilana's premium line of saw blades for cutting of laminated chipboards, MDF and HDF featuring larger TCT tips that allow for more resharpening
- » low noise slots for additional silencing of the saw blade
- » supplied in TFZ geometry
- » for optimal cutting the use of a scoring blade is recommended

D	S	s	d	z	●/○
300	3,2	2,2	30	96	●

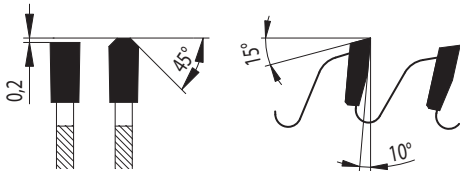

97 TFZ L HP



- » designed for cutting of chipboard based materials, MDF and HDF
- » for optimal cutting the use of a scoring blade is recommended
- » long lifespan of carbide tips

D	S	s	d	z	●/○
200	3,2	2,2	30	64	●
250	3,2	2,2	30	60	●
250	3,2	2,2	30	80	●
300	3,2	2,2	30	72	●
300	3,2	2,2	30	96	●
350	3,6	2,5	30	108	●

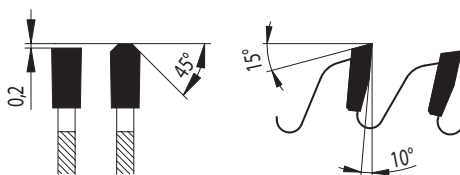

In case that you did not find the type of saw blades you require in our catalogue, please contact us. We will make them upon your specification.

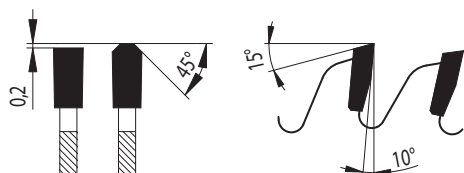

97-11 TFZ L



Characteristics:

- » suitable for cutting of laminated chipboards
- » for optimal cutting the use of a scoring blade is recommended
- » low noise slots for additional silencing of the saw blade

D	S	s	d	z	●/○
200	3,2	2,2	30	64	●
250	3,2	2,2	30	80	●
300	3,2	2,2	30	96	●
350	3,6	2,5	30	108	●

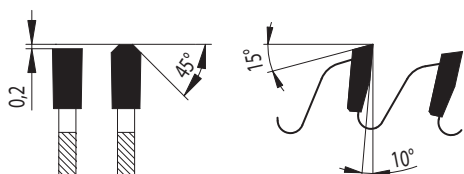

97-13 TFZ L



Characteristics:

- » suitable for cutting of laminated chipboards
- » for optimal cutting the use of a scoring blade is recommended
- » low noise slots for additional silencing of the saw blade

D	S	s	d	z	●/○
250	3,2	2,2	30	60	●
300	3,2	2,2	30	72	●

In case that you did not find the type of saw blades you require in our catalogue, please contact us. We will make them upon your specification.

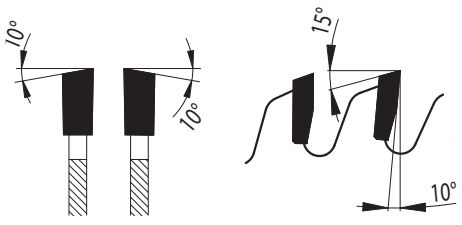

98 WZ L HP



- » designed for cutting of chipboard based materials, MDF and HDF
- » for optimal cutting the use of a scoring blade is recommended
- » long lifespan of carbide tips

D	S	s	d	z	●/○
250	3,2	2,2	30	64	●
250	3,2	2,2	30	72	●
300	3,2	2,2	30	72	●
300	3,2	2,2	30	96	●
350	3,6	2,5	30	84	●
350	3,6	2,5	30	108	●

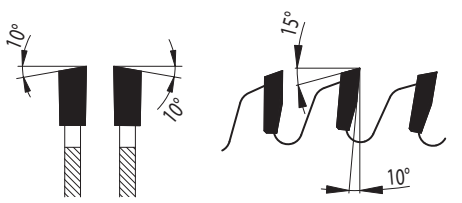

98-11 WZ L



- » suitable for cutting of laminated chipboards
- » for optimal cutting the use of a scoring blade is recommended
- » low noise slots for additional silencing of the saw blade

D	S	s	d	z	teeth	●/○
250	3,2	2,2	30	72	WZ L	●
300	3,2	2,2	30	96	WZ L	●
350	3,6	2,5	30	108	WZ L	●

In case that you did not find the type of saw blades you require in our catalogue, please contact us. We will make them upon your specification.

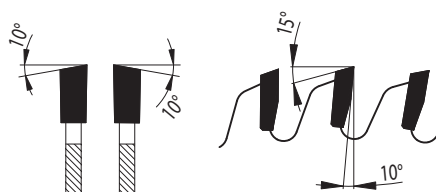

98-13 WZ L



Characteristics:

- » suitable for cutting of laminated chipboards
- » for optimal cutting the use of a scoring blade is recommended
- » low noise slots for additional silencing of the saw blade

D	S	s	d	z	●/○
250	3,2	2,2	30	64	●
300	3,2	2,2	30	72	●
350	3,6	2,5	30	84	●

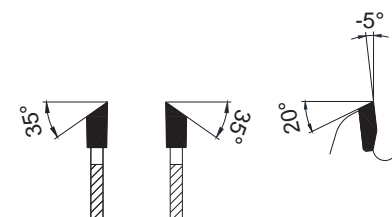

98-11 WZ L N



- » suitable for cutting of laminated chipboards
- » for optimal cutting the use of a scoring blade is recommended
- » low noise slots for additional silencing of the saw blade

D	S	s	d	z	teeth	●/○
250	3,2	2,2	30	80	WZ L N	○
300	3,2	2,2	30	96	WZ L N	○
350	3,6	2,5	30	108	WZ L N	○

In case that you did not find the type of saw blades you require in our catalogue, please contact us. We will make them upon your specification.



90 DHZ/N HP

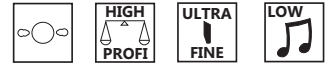

- » cutting of laminated boards with or without the use of a scoring blade
- » suitable for use in vertical panel saws
- » low noise slots for additional silencing of the saw blade
- » ground bore ensures top run-out parameters of the saw

D	S	s	d	z	teeth	●/○
220	3,2	2,2	30	42	DHZ	●
250	3,2	2,2	30	48	DHZ	●
303	3,2	2,2	30	60	DHZ / DHZ N	●
350	3,6	2,5	30	72	DHZ	●

90 DHZ HP / DHZ

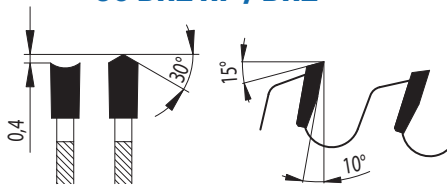

90 DHZ N HP / DHZ N

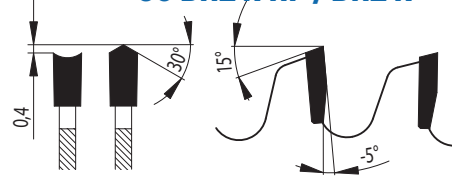

90 DHZ/N



- » cutting of laminated boards with or without the use of a scoring blade
- » suitable for use in vertical panel saws
- » low noise slots for additional silencing of the saw blade

D	S	s	d	z	teeth	●/○
220	3,2	2,2	30	42	DHZ	●
250	3,2	2,2	30	48	DHZ	●
303	3,2	2,2	30	60	DHZ / DHZ N	●
350	3,6	2,5	30	72	DHZ	●

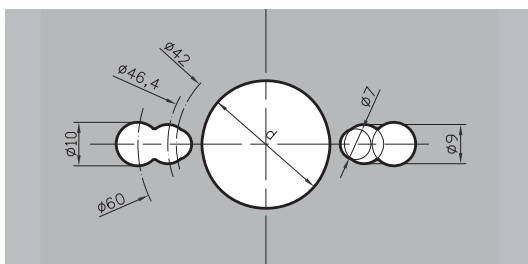

All sizing saw blades include pinholes.
Parameters of pinholes are shown on the left.
Versions without pinholes can be produced on request.

In case that you did not find the type of saw blades which you require in our catalogue, please contact us. We will make them upon your specification.

Material: Synthetic materials
Application: Cutting of boards, sizing
Machine: Sizing machines

97 CORIAN

- » designed for sizing of boards with the use of a scoring saw blade
- » suitable for cutting of synthetic materials based on natural minerals and pure acrylic polymer Corian, HI-MACS, Varicor, Staron, Marlan
- » special TCT tips with tooth geometry for a long life and an excellent cutting edge

D	S	s	d	z	teeth	●/○
300	3,2	2,5	30	84	TZ/TZ	●

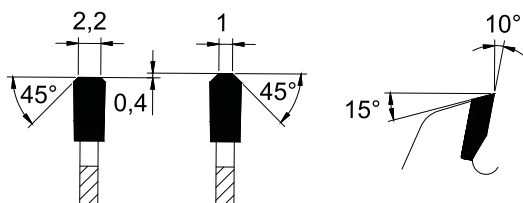

Material: Laminated boards, chipboards
Application: High quality of cut on the bottom side of laminated materials
Machine: Panel sizing saws with scoring saw blade accessory

93.1 FZ - SPLIT SCORING



- » suitable for panel sizing
- » possibility to set up kerf with shims

D	S	d	z	teeth	●/○
80	2,8 - 3,6	20, 22	10+10	FZ	○
100	2,8 - 3,6	20, 22	12+12	FZ	●
120	2,8 - 3,6	20, 22	12+12	FZ	●
125	2,8 - 3,6	20, 22	12+12	FZ	●
140	2,8 - 3,6	20, 22	14+14	FZ	●
160	2,8 - 3,6	20, 22	16+16	FZ	●

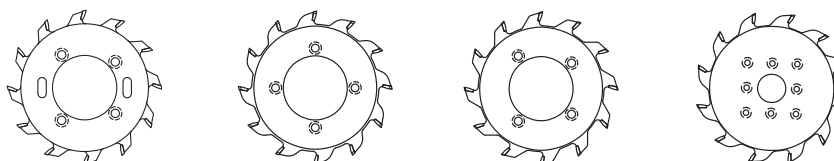
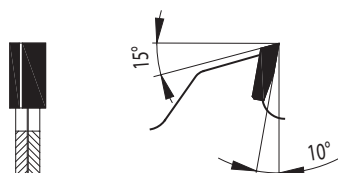

In case that you did not find the type of saw blades you require in our catalogue, please contact us. We will make them upon your specification.



93.1WZ - SPLIT SCORING

- » suitable for panel sizing
- » possibility to set up kerf with shims



D	S	d	z	teeth	●/○
120*	2,8 - 3,6	50	12+12	WZ	●
125	2,8 - 3,6	30	12+12	WZ	●

* suitable for Altendorf - Rapido and related systems

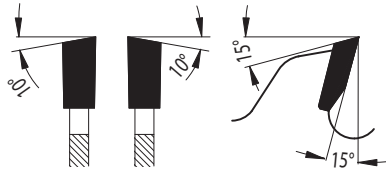
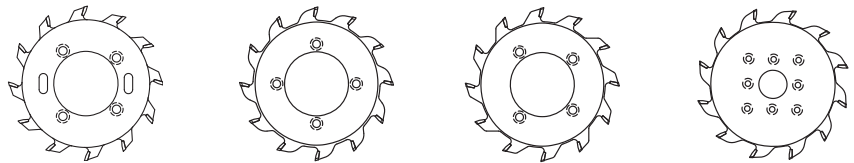

93 KON FZ



- » scoring saw blades for equipment with the possibility of height adjustment of the scoring saw blade accessory

D	S	s	d	z	●/○
100	3,1 - 4,2	2,2	20	20	●
100	3,5 - 4,5	2,5	20	20	●
125	3,1 - 4,2	2,2	20	24	●
140	3,1 - 4,2	2,2	20	32	
200	3,1 - 4,2	2,2	30	32	

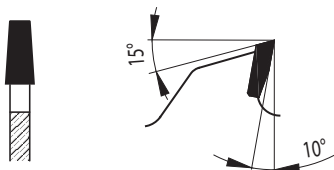

In case that you did not find the type of saw blades you require in our catalogue, please contact us. We will make them upon your specification.

TCT Saw Blades and Segments for Hogging Machines



Material: Chipboard and MDF based materials
Application: Panel sizing saws



86 – TCT Hogging Saw Blades

- » sizing in combination with segments mounted on a hogging head
- » dimensions manufactured based on customer's request

D	S	s	d	z	teeth	●/○
360	4,4	3,0	135	48	TFZ-L/R	○
260	4,4	2,8	80	48	FZ-L/R	○
355	4,4	3,0	120	60	ES-L/R	○
200	4,0	2,8	80	48	FZ-L/R	○
305	4,1	2,8	155	72	ES-L/R	○
355	4,4	3,0	80	72	WZ-L/R	○
405	4,4	3,0	80	84	ES-L/R	○
395	4,4	3,5	80	84	ES-L/R	○
305	4,1	2,8	155	72	ES-L/R	○

FZ		ES		WZ		WZW	
L	R	L	R	L	R	L	R



Material: Chipboard and MDF based materials
Application: For complete chipping (disintegration) of waste materials
Machine: Mounted on a segmental hogging head

50 – Hogging Saw Segments

- » segments fitted with tungsten carbide tips
- » other dimensions and types of segments can be produced based on customer's request

In case that you did not find the type of saw blades you require in our catalogue, please contact us. We will make them upon your specification.

pilana.com



pilana.com

TCT Saw Blades

for Non-Ferrous
Metals, Thin Walled
Profiles, Plastics
and Dry-cutting



TCT Saw Blades for Cutting of Non-Ferrous Metals and Plastics



Material: Non-ferrous metals and plastics
Application: Profiles, mouldings, solid materials, tubes
Machine: Automatic feed machines

87-13 TFZ P



Characteristics:

- » cutting of aluminum profiles and mouldings, plastic boards, brass (Pertinax)
- » suitable for angle cutting and cross cutting
- » saw blades are equipped with Cu rivets

D	S	s	d	z	●/○
200	3,2	2,5	30	48	●
250	3,2	2,5	30	60	●
300	3,2	2,5	30	72	●
350	3,6	2,8	30	84	●
400	3,6	2,8	30	96	●
450	4,0	3,2	30	108	●
500	4,0	3,2	30	120	●



87-11 TFZ P



Characteristics:

- » cutting aluminum profiles and mouldings, plastic boards, brass (Pertinax)
- » suitable for cutting of thin-walled profiles
- » suitable for angle cutting and cross cutting
- » saw blades are equipped with Cu rivets

D	S	s	d	z	●/○
250	3,2	2,5	30	80	●
300	3,2	2,5	30	96	●
350	3,6	2,8	30	108	●
400	3,6	2,8	30	120	●

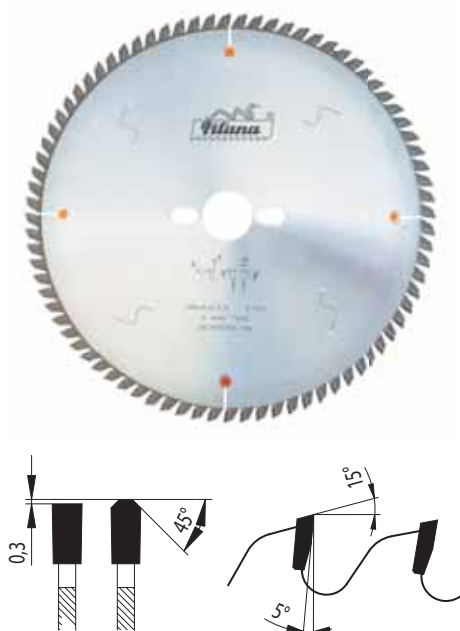

All saw blades include pinholes.
 Parameters of pinholes are shown on the left.
 Versions without pinholes can be produced on request.

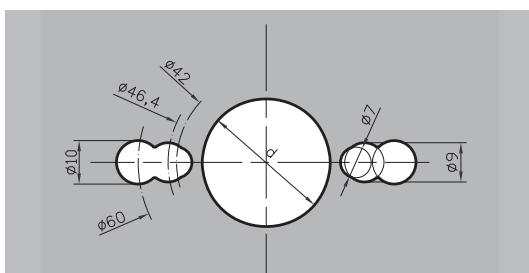

In case that you did not find the type of saw blades you require in our catalogue, please contact us. We will make them upon your specification.

Material: Non-ferrous metals and plastics
Application: Profiles, mouldings, solid materials, tubes
Machine: Manual feed machines

87-13 TFZ N



Characteristics:

- » cutting of non-ferrous metals, profiles and plastics
- » suitable for angle cutting and cross cutting
- » saw blades are equipped with Cu rivets

D	S	s	d	z	●/○
250	3,2	2,5	30	60	●
300	3,2	2,5	30	72	●
350	3,6	2,8	30	84	●
400	3,6	2,8	30	96	●
420	4,0	3,2	30	96	●
450	4,0	3,2	30	108	●
500	4,0	3,2	30	120	●

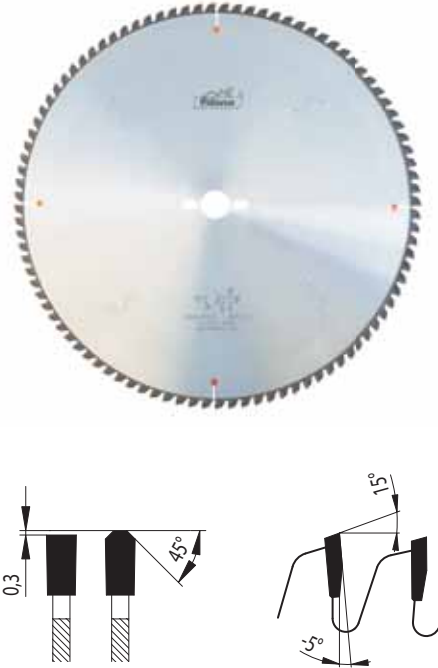

87-11 TFZ N



Characteristics:

- » cutting of non-ferrous metals, profiles and plastics
- » suitable for angle cutting and cross cutting
- » suitable for cutting of thin-walled profiles
- » saw blades are equipped with Cu rivets

D	S	s	d	z	●/○
160	2,8	2,2	20	48	●
190	2,8	2,2	30	56	●
200	3,2	2,5	30	60	●
210	3,2	2,5	30	60	○
216	2,8	1,8	30	80	●
216	3,2	2,5	30	60	○
250	3,2	2,5	30	80	●
260	3,2	2,5	30	80	○
300	3,2	2,5	30	96	●
330	3,2	2,5	30	96	○
350	3,6	2,8	30	108	●
380	3,6	2,8	30	110	○
400	3,6	2,8	30	120	●

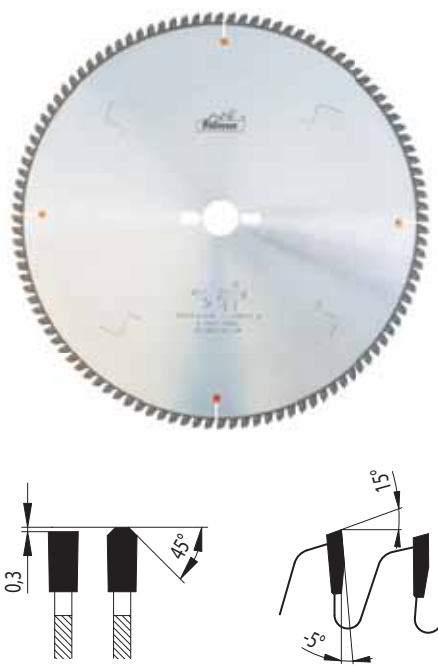

In case that you did not find the type of saw blades you require in our catalogue, please contact us. We will make them upon your specification.

TCT Saw Blades for Cutting of Non-Ferrous Metals and Plastics



Material: Non-ferrous metals and plastics
Application: Profiles, mouldings, solid materials, tubes
Machine: Automatic or manual feed machines

87 TFZ P



- » for cutting of plastic, aluminium and duralumin mouldings and profiles, plastic boards, synthetic resins (Pertinax)
- » saw blades are equipped with Cu rivets

D	S	s	d	z	●/○
400	4,2	3,6	30	120	●
420	4,2	3,6	30	120	●
450	4,2	3,6	30	120	●
500	4,2	3,6	30	120, 144	●
500	4,4	3,8	30	96, 120	●
550	4,4	3,8	30	108, 144	●
600	4,6	4,0	30	140	●
650	5,2	4,4	30	144	●



87 TFZ N



- » for cutting plastic, aluminium and duralumin mouldings and profiles, plastic boards, synthetic resins (Pertinax)
- » suitable for cross-cut or miter cutting applications
- » saw blades are equipped with Cu rivets

D	S	s	d	z	●/○
400	4,2	3,6	30	128	●
420	4,2	3,6	30	120	●
450	4,2	3,6	30	128	●
500	4,2	3,6	30	144	●
500	4,4	3,8	30	96, 120	●
550	4,4	3,8	30	108, 128	●
600	4,6	4,0	30	140	●
650	5,2	4,4	30	144	●

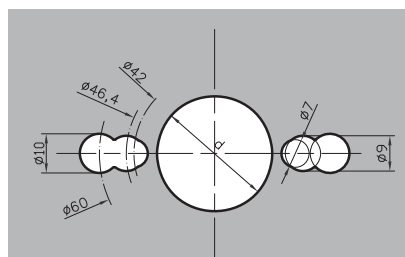
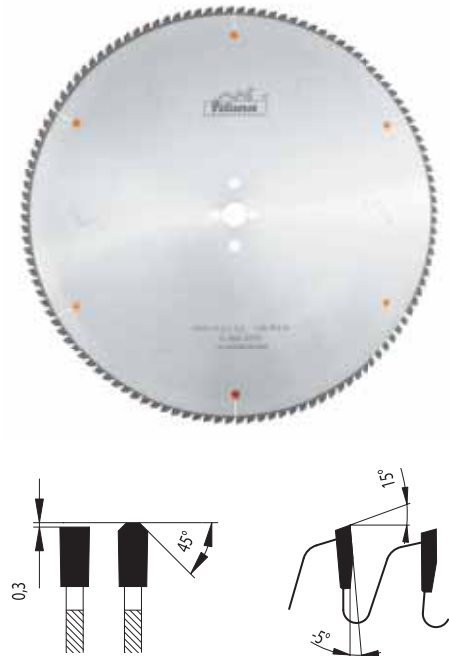

All the "87 series" saw blades till diameter 450 are equipped with universal pin holes seen on the left. From diameter 500 there are no pinholes in the saw blades and are made upon request.

In case that you did not find the type of saw blades you require in our catalogue, please contact us. We will make them upon your specification.

Material: Plastic window frames

Application: Grooving, crosscutting, angle cutting

87.1



- » used to cut and clean profiles, window ledges and laths in plastic windows, doors production
- » used in sets, for single or double-sided miter or cross cutting
- » tooth geometry designed to reach high-quality and precise cut in thin-walled materials



ES-L

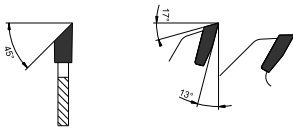

ES-R

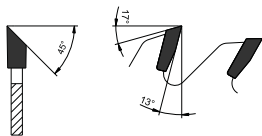

TFZ N

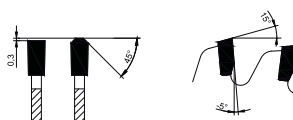

FZ N

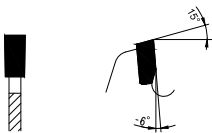

D	S	s	d	z	Teeth
95	2,1	1,6	20	20	ES-L/ES-R
98	3	2,5	32	36	ES-L/ES-R
103	2,1	1,6	32	24	ES-L/ES-R
103	2,1	1,6	32	40	ES-L/ES-R
175	2,2	1,8	20	68	TFZ N
200	2	1,6	30	100	TFZ N
200	2,2	1,8	20, 32	100	TFZ N
250	2,2	1,8	30	100, 120	TFZ N
250	2,6	2	30	100	TFZ N
250	4,5	3,5	20	56+8	FZ N
250	4,5	3,5	20	68+5	FZ N
250	5	4	32	32	FZ N
250	5	4	32	63+5	FZ N

In case that you did not find the type of saw blades you require in our catalogue, please contact us. We will make them upon your specification.

Material: Building materials, sandwich panels, thin steel profiles
Application: Universal usage in building industry
Machine: Miter saws or dry-cut machines

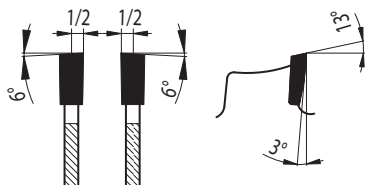

88 WZ/FA – DRY CUT



Characteristics:

- » for cutting without cooling of sandwich materials made of thin carbon steel or aluminium outer walls, filled with composites, mineral wool or PUR foam, thin steel or aluminium profiles with thickness up to 0,5 mm (typically dry wall profiles)
- » to be used on table saws, radial arm saws and hand-held/dry cut machines with reduced RPM (see table), i.e. Jepson, Elu, Ryobi, Makita, Milwaukee, DeWalt, Black&Decker, etc...
- » suitable for manual or automatic feed

D	S	s	d	z	●/○
150	2,2	1,6	20	30	●
160	2,2	1,6	20	30	●
180	2,2	1,6	20	36	●
190	2,4	1,8	20	38	●
200	2,4	1,8	20	40	●
210	2,4	1,8	30	40	●
230	2,4	1,8	30	44	●
235	2,4	1,8	30	44	●
250	2,4	2,0	30	48	●
300	2,4	2,0	30	60, 80	●
305	2,4	2,0	25,4	60, 80	●
350	2,6	2,2	30	80	●
355	2,6	2,2	25,4	80, 90	●

D	160	190	200	250	300	350	400	450
Recommended RPM	4000	3500	3000	2000	1500	1500	1000	1000

In case that you did not find the type of saw blades you require in our catalogue, please contact us. We will make them upon your specification.

Material: Non-ferrous metals and plastics
Application: Profiles, mouldings, solid materials, tubes
Machine: Automatic feed machines

87 PLEXI K/WZ/FA

- » designed for formatting of boards or cross cutting as well as for use in portable machines
- » suitable for cutting of transparent PMMA thermoplastics, plexiglass and PU boards
- » TCT tips with special geometry and convex side edges of the tooth for excellent cutting edge

D	S	s	d	z	Geometry	●/○
300	3,2	2,5	30	60	K/WZ/FA	●
300	3,2	2,5	30	96	K/WZ/FA	●
350	3,5	2,8	30	108	K/WZ/FA	●
350	4,4	3,2	30	72	K/WZ/FA	○
350	4,4	3,2	60	72	K/WZ/FA	○

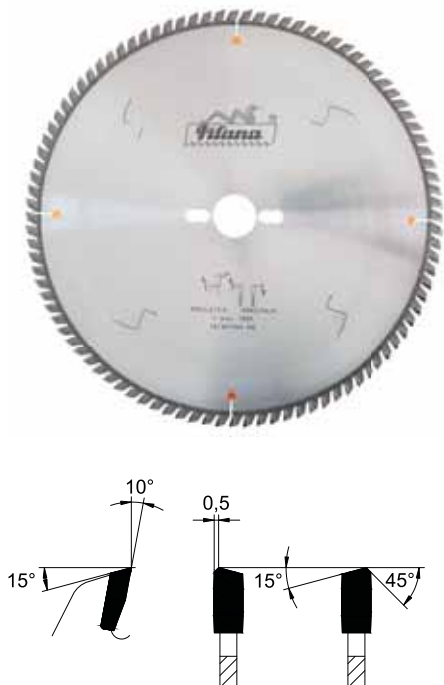

87 PROFILE SUPERIOR CUT WZ/FA

- » for extremely smooth edges
- » suitable for cross cutting, miter cutting or optimizing of profiles in non-ferrous metals, plastics especially acrylic glass or lacquered profiles, polycarbonat (LEXAN)
- » TCT tip with double hook angle and tooth geometry WZ/FA for excellent cutting edge without additional working steps

D	S	s	d	z	Geometry	●/○
300	3,0	2,4	30	96	WZ/FA	●

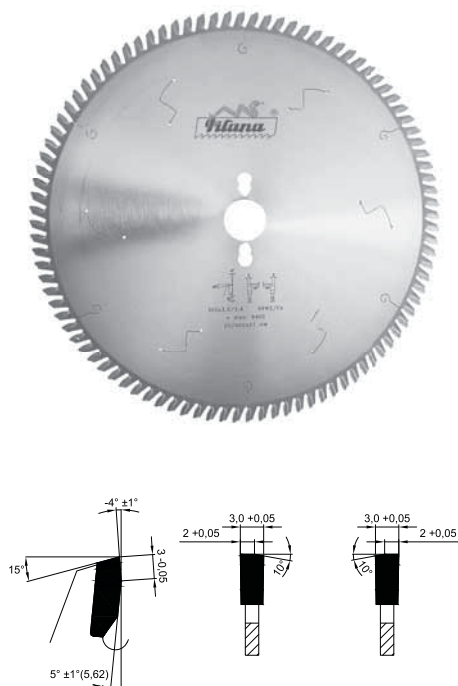

In case that you did not find the type of saw blades which you require in our catalogue, please contact us. We will make them upon your specification.

pilana.com



pilanawood.com

TCT or CERMET Saw Blades for Steel Cutting



Material:	Ferrous metals
Application:	Solid materials, tubes, pipes, profiles, tubes
Machine:	High performance circular saw blade machines



METAL SPEED S/C - THROW AWAY TYPE

Cermet tipped (C or CH)

- » throw away circular saw blades for structural and low alloyed steels with carbon content less than 0,45% approx. (750-800 N/mm²)
- » „H“ version to be applied on non-alloy or alloyed steels with higher tensile strength (special tooth design, please refer to the sketch below)

TC tipped (S or SH)

- » for alloyed steels with more than 0,45% carbon content, high strength steels (800 N/mm² +), stainless steels, bearing steels, etc.
- » „H“ version to be applied on steels with difficult cutting conditions – Ti/Ni based „superalloys“ (special tooth design, please refer to the sketch below)

„H“ version picture

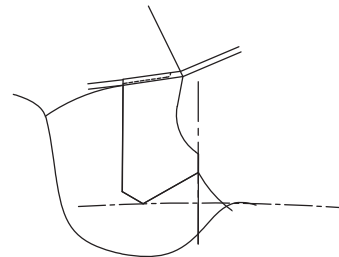

IMPORTANT GENERAL INFORMATION

- » for cutting of solid and pipes on stationary cutting machines (Adige, Rattunde, ExactCut, Amada, Tsune, RSA, Nishijimax, etc.) and also in bulk cutting. For flying cut-off or orbital cutting/milling machines see next pages;
- » optional PVD coating (AlTiN, AlTiCrN, etc.) for specific applications (stainless, high Ni content, tubes, Ti based „superalloys“ etc.) is recommended;
- » for Ni/Ti based alloys dedicated special cooling fluid must be used, please talk to your supplier!
- » dimensions and teeth numbers are on request

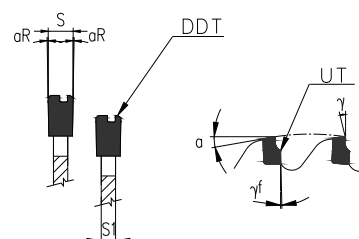

In case that you did not find the type of saw blades you require in our catalogue, please contact us. We will make them upon your specification.

TYPICAL SIZES AND APPLICATIONS

Ø (mm)	kerf/body (mm)	main bore + pin holes (mm)	teeth count	typical application
250	2,0/1,75	32 + 4/9/50 + 4/11/63	60/72/80	solid
		40 + 4/11/80 + 4/12/64	80/90	tube
285	2,0/1,75	32 + 4/9/50 + 4/11/63	60/72/80	solid
		40 + 4/11/80 + 4/12/64	80/90/110	tube
315	2,3/2,0	32 + 4/11/63 + 4/9/50	60/72/80	solid
		40 + 4/11/80 + 4/12/64	80/90/110	tube
350	2,7/2,4	50 + 4/16/80	80/100/120/140	tube
360	2,6/2,25	40 + 4/16/80 + 4/12/90	60/80/100	solid
		50 + 4/16/80 + 4/11/90	80/100/120/130	tube
425	2,7/2,25	40 + 4/16/80 + 4/12/90	50/60/72/80/100	solid
		50 + 4/16/80 + 4/11/90	100/120/130	tube
460	2,7/2,25	40 + 4/16/80 + 4/12/90	40/50/60/80/100	solid
		50 + 4/16/80 + 4/11/90	100/120/140	tube
560	3,5/3,0	50 + 4/16/80 + 4/11/90	40/50/60/80	solid
580	3,2/2,7	80 + 4/22/120	40/50/60/80	solid
620	3,5/2,7	50 + 4/15/80	48/60/72	solid
750	3,8/3,2	80 + 4/21/80	60/80/100	solid

TYPICAL APPLICATION VALUES

Material grade	Solid/tube	Blade type	Cutting speed m/min	Feed speed Fz/tooth	PVD coating
St37	Solid	Metal speed C	110-140	0,06-0,08	
42 CrMo4	Solid	Metal speed CH	90-110	0,04-0,06	
44 MnSiV	Solid	Metal speed CH	90-110	0,04-0,06	
C45	Solid	Metal speed C	90-110	0,05-0,07	
20CrMo5	Solid	Metal speed C	100-125	0,06-0,07	
100 Cr6	Solid	Metal speed S	70-90	0,04-0,06	yes
50CrV4	Solid	Metal speed S	80-90	0,04-0,05	yes
X20Cr13	Solid	Metal speed SH	50-90	0,04-0,05	yes
St52	Tube	Metal speed S	230-270	0,04-0,08*	yes
E275/355+C	Tube	Metal speed CH	220-250	0,04-0,15*	yes

* variable feed speed in cut (entry – centre – exit)

- » cutting speed for tube cutting can be raised for thin walled tubes/profiles to eliminate vibrations
- » values are typical only, please consult with our technical department prior to ordering

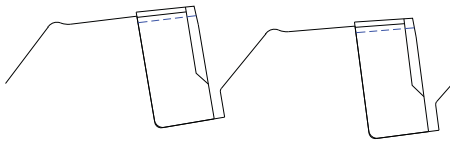

Blades for single/twin flying cut-off machines (ERW/HFW steel pipes and profiles)

- » PVD coated carbide tipped saw blade for pipe/tube and construction steel profiles (HSS) cutting on fly cutting machines
- » limited regrinding possibilities
- » high cutting speed with burr-free and smooth surface
- » to be used on tube/profile forming lines of the tube mills
- » for Adige, Oto Mills, Sinico, Adda Fer, etc.

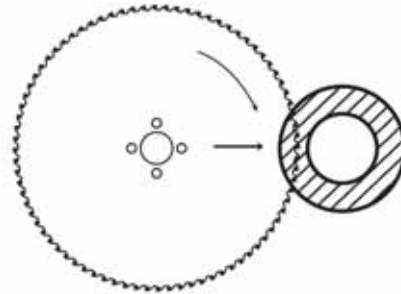

NEW

For loose or/and heavy inner scarf applications we offer special tooth and blade design to protect cutting tip from early damage.

TYPICAL SIZES AND APPLICATIONS

Ø (mm)	kerf/body (mm)	main bore + pin holes (mm)	tooth count	typical application
400	2,8/2,5	50 + 4/16/80	100/120/130	Fly cut-off tube
450	2,8/2,5	50 + 4/16/80	100/120/140	Fly cut-off tube
500	3,5/3,0	50 + 4/16/80	120/140/160	Fly cut-off tube
		90 + 3/12,5/160	120/140/160	Fly cut-off tube
550/560	3,7/3,2	80 + 4/23/120	120/140/160/170	Fly cut-off tube
600	3,6/3,0	90 + 3/12,5/160	130/140/160/180	Fly cut-off tube
650	3,8/3,2	140 + 4/18/170	150/160/180	Fly cut-off tube

TYPICAL APPLICATION VALUES

Material grade	Solid/tube	Blade type	Cutting speed m/min	Feed speed Fz/tooth	PVD coating
E235	tube	Metal speed SH	350-400	0,04-0,12*	yes
St52	tube	Metal speed SH	350-400	0,03-0,1*	yes
HSLA100	tube	Metal speed SH	350-400	0,03-0,08*	yes

* variable feed speed in cut (entry - centre - exit)



BLADES FOR ORBITAL CUTTING LINES (ERW/HFW steel pipes and profiles)

- » carbide tipped saw blade for pipe and tube cutting on orbital cutting machines, construction profiles (HSS)
- » possibility of regrinding
- » PVD coating
- » for Nakata, SMS-Meer, Adda Fer, Kusakabe, etc

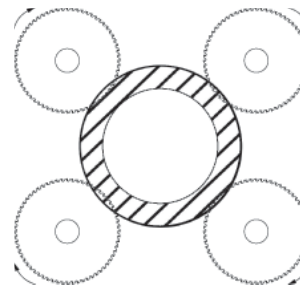

Dimensions and teeth numbers are on request.

TYPICAL SIZES AND APPLICATIONS

Ø (mm)	kerf/body (mm)	main bore + pin holes (mm)	tooth count	typical application
250	3,2/2,5	45 + 4/16/80	52/64/72	Orbital fly cut-off tube
300	3,2/2,5	80 + 4/16/80	52/64/72	Orbital fly cut-off tube
350/355	3,2/2,5	80 + 4/16/80	52/64/72	Orbital fly cut-off tube
	3,8/3,0	80 + 3/12,5/160	52/64/72	Orbital fly cut-off tube
380	3,8/3,0	115 + 4/21/200	52/64/70	Orbital fly cut-off tube
	4,3/3,2	115 + 4/21/200	52/64/70	Orbital fly cut-off tube

TYPICAL APPLICATION VALUES

Material grade	Solid/tube	Blade type	Cutting speed m/min	Feed speed Fz/tooth	PVD coating
E235	tube	Metal standard	300-350	0,05-0,25*	yes
E355	tube	Metal standard	300-350	0,05-0,25*	yes

* variable feed speed in cut (entry - centre - exit)



METAL STANDARD

- » cutting of solids, tubes and construction profiles (HSS), rail tracks, large billets
- » non-alloy or alloy steels, bearing steel
- » possibility of regrinding
- » number of teeth and type of blade depending on application
- » diameter of the blade: from 280 to 1300 mm

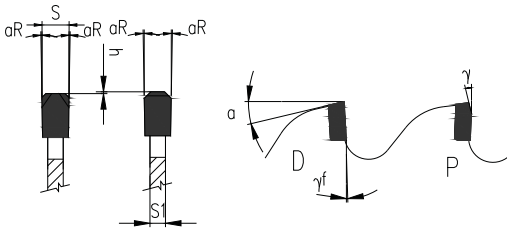

TCT Metal standard (typical sizes)

Ø (mm)	kerf/body (mm)	main bore + pin holes (mm)	tooth count	typical application
630	6,5/5,0	80 + 8/27/160	60	rail cutting
720	5,5/4,5	80 + 8/32/200	60/72/80	large steel billets
760	5,5/4,5	80 + 8/27/160	60/80/100	steel billets/thick wall tubes
860	7,0/5,5	80 + 8/32/200	60	steel billets

- many other sizes upon request for Linsinger, Wagner, Kasto machines...

Material: Ferrous & nonferrous metals
Application: Solid materials, pipes, profiles, tubes
Machine: Automatic or manual feed machines

METAL CUT

- » for quick dividing without cooling of bars, pipes, tubes and profiles made of construction steels or aluminium alloys with approximate wall thickness 0,5-6 mm
- » to be used on cut-off, table saws, radial arm saws and hand-held/dry cut machines with reduced RPM (see table), for example Jepson, Elu, Ryobi, Makita, Milwaukee, DeWalt, Black&Decker, etc...
- » special geometry and TCT grade enhances lifetime of the cutting edge, cut quality and multiple use of the saw blade
- » TCT tips are resharpenable



WZ/FA

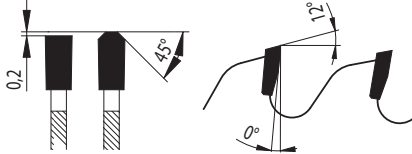

WZ/FA/F

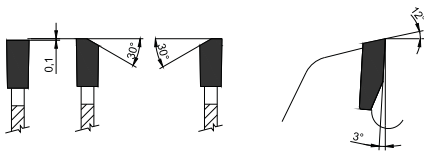

D	S	s	d	z	Geometry	●/○
180	1,8	1,4	20	44	WZ/FA	●
190	1,8	1,4	20	48	WZ/FA	●
305	2,2	1,8	25,4	60	WZ/FA/F	●
305	2,2	1,8	25,4	78	WZ/FA/F	●
355	2,2	1,8	25,4	66	WZ/FA/F	●
355	2,2	1,8	25,4	90	WZ/FA/F	●

D	160	190	200	250	300	350	400	450
Recommended RPM	4000	3500	3000	2000	1500	1500	1000	1000

CERMET

- » cutting of steel & plastic pipes with a hand machine
- » standard steels, stainless, copper, plastics
- » cermet tipped circular saw blade for heavy duty applications, saw blade can be sharpened



D	S	s	d	z	Geometry
140	1,8	1,4	62	46	WZ/FA
165	1,8	1,4	62	54	WZ/FA

Dimensions and teeth numbers are on request.

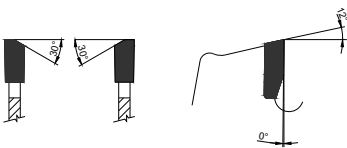

Tab. no. 3: Teeth number indication based on material size - full materials

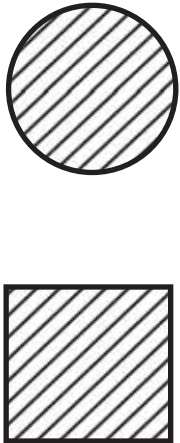

D - Blade diameter [mm]	Number of Teeth	Ø of cutting materials											
		20	30	40	50	60	70	80	90	100	120	140	
250	60		●	●	●	●							
	72	●	●										
	80	●											
285	60			●	●	●	●						
	72		●	●	●	●							
	80	●	●	●	●								
315	60		●	●	●	●	●	●					
	80	●	●	●	●	●							
360	60			●	●	●	●						
	80		●	●	●	●							
	100	●	●	●	●								
420	60				●	●	●	●	●	●	●	●	
	80			●	●	●	●	●					
460	60								●	●	●	●	●
	80					●	●	●	●	●	●		
	100			●	●	●	●	●	●	●			

● Recommended

Tab. no. 4: Teeth number indication based on material size - tubes, profiles

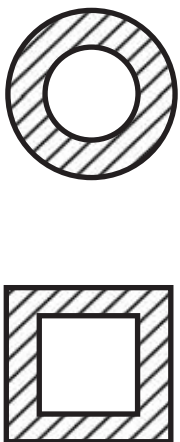

D - Blade diameter [mm]	Wall thickness	Ø of cutting materials									
		30	40	50	60	70	80	90	100	120	
315	3-5	110	110	100	100	100	100				
360	3-6		120	120	100	100	100	80	80		
400	3-6		140	140	140	120	120	100	100		
	6-10		120	120	120	100	100	100	100		
460	3-6			140	140	120	120	120	120		
	6-10			140	120	120	100	100	100		
500	5-10				160	140	140	120	120		
	> 10				160	140	140	120	120		
560	5-10					160	160	140	140	120	
	> 10					160	160	140	140	120	

pilana.com



pilanawood.com

Special TCT Saw Blades, Segments Reduction and Distance Rings



Material:	Rock / mineral wool
Application:	Solid materials
Machine:	Automatic feed machines

95 MINERAL/ROCK WOOL

- » cutting along and across of mineral fibres
- » specially designed saw body improves resistance against abrasive wear
- » TCT saw blades for cutting of mineral fibres are produced in all dimensions on request of our customers

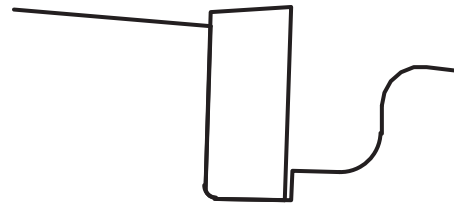

Thin Kerf TCT Saw Blades

- » suitable for cutting of standard and higher quality dry woods
- » applicable in production of floors or furniture for cross cutting and cutting along the grain
- » less force during feeding, better energy effectiveness and less waste produced
- » produced with black coating for smoother surface of the body and extra tensioning in the body to prevent wobbling
- » thin kerf saw blades are produced in diameters from 100 - 250 mm, body thickness 0,9 - 1,2 mm

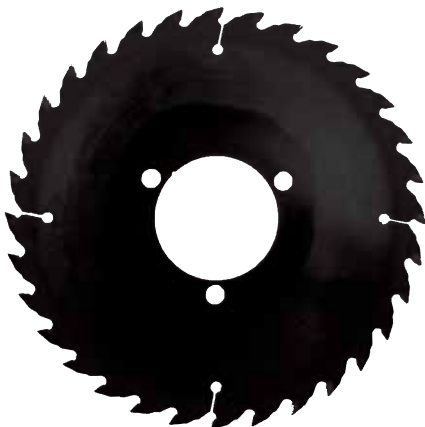

Material: Meat
Application: Meat processing
Machine: Manual feed machines, hand machines

55 WZ FOOD INDUSTRY Saw Blades

- » supplied in WZ tooth shape with stainless steel body
- » used in slaughter houses for industrial breaking of meat for EFA (SCHMID & WEZEL), FREUND, JARVIS and many other brands

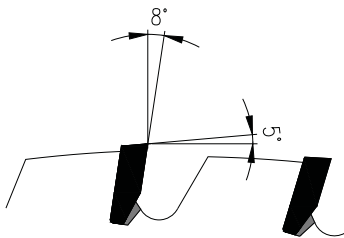

D	S	s	d	z
180	1,9	1,5	*	44
210	1,9	1,5	*	40
230	1,9	1,5	*	44
270	1,9	1,5	*	52
270	2	1,6	*	48
300	2	1,6	*	52
330	1,9	1,5	*	46
360	2	1,6	*	64

* to customer request

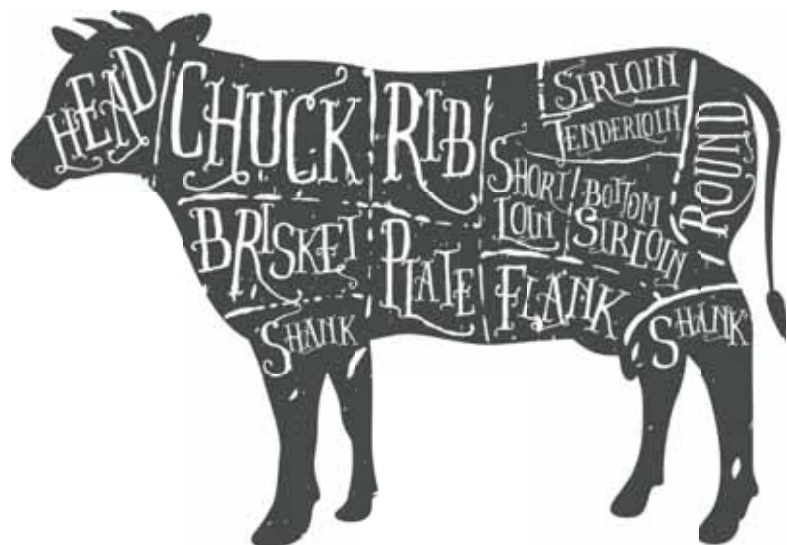
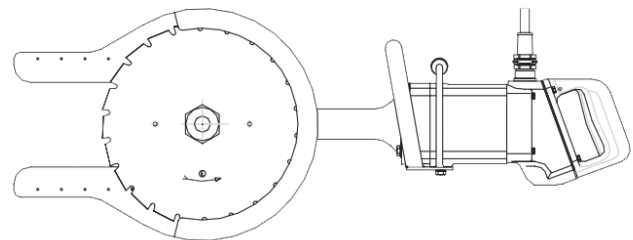

In case that you did not find the type of saw blades you require in our catalogue, please contact us. We will make them upon your specification.



WE CARRY OUT:

- » blade modifications (bores and holes) to fit various machinery brand requirements
- » production of saw blades and segments based on customer's drawing documentation up to 1 300 mm in diameter
- » development and production based on cutting conditions and requirements of individual wood processing companies
- » development and production of saw blades in cooperation with wood-processing machinery manufacturers



Reduction Rings

Ring sizes available upon request

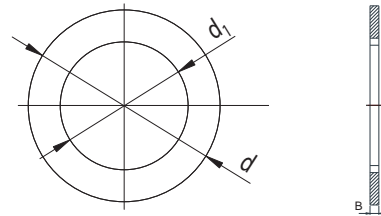

Hogging Heads

- » for longitudinal and transverse hogging with or without the use of a scoring blade
- » quality of cutting edges depends on the type of circular saw blade used
- » for gradual cutting with TCT tipped segments
- » for particulate or fibrous materials like chipboard or MDF with or without a laminated or veneered layer



TCT Segments Accessories

- » steel jigs for fastening of TCT segments or ring saws used in primary processing of goods
- » to be used in machines for primary processing of wood

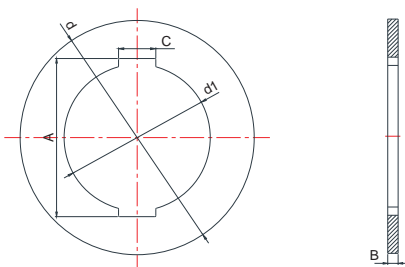

Distance rings

- » to be used to distance saw blades on a shaft
- » made of steel
- » dimensions on request

How to order:

- » $d \times d1 \times B + C/A$

pilana.com



pilanawood.com



PCD Saw Blades



Material: Coated and uncoated chipboards, coated and uncoated MDF, various plastic materials, non-ferrous metals, building and insulation materials

Machine: Panel sizing saws, forming saws, hand saws

- » saw blades are tipped with tips made from polycrystalline diamonds (PCD)
- » saw blades are suitable for panel sizing applications of single boards
- » for MDF, HDF, HPL, laminated or melaminated chipboards, panels made of composite materials, panels used in flooring, aluminium and plastic profiles



77 PCD SAW BLADE

D	S/s	d	z	Teeth	●/○
303	3,2 / 2,4	30	60	KX/WZ	●

* other dimensions and tooth geometries on request

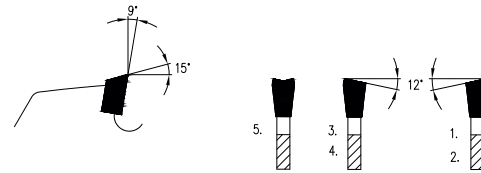

73 FZ and KON PCD Scoring Saw Blades

- » scoring saw blades suitable for cutting applications together with panel sizing saw blades

D	S/s	d	z	Teeth	●/○
120	2,8 - 3,6	20	12+12	FZ	○
120	2,8 - 3,6	50 ¹⁾	12+12	FZ	●
120	2,8 - 3,6	30 ²⁾	12+12	FZ	●
125	2,8 - 3,6	20	12+12	FZ	○
180	4,3 - 5,1 / 3,5	30	30	KON	○
200	4,3 - 5,1 / 3,5	20	30	KON	○

1/ Rapido 2/ Dimar

TFZ

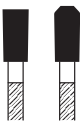

KON



WZ

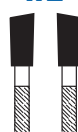

DZ/TZ

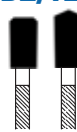

FZ



TZ/TZ

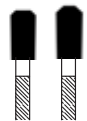

77 FZ PCD Saw Blades

- » for Cembrit, Varicor, Trespa, eternit and acrylic boards
- » available tip height sizes 3,0 and 5,6 mm

D	S/s	d	z	Teeth
160	2,2/1,6	20	4, 6, 8, 12, 20	FZ, TZ, RZ
190	2,2/1,6	20	4, 6, 8, 12, 20	FZ, TZ, RZ
210	2,2/1,6	20	4, 6, 8, 12, 20	FZ, TZ, RZ
230	2,2/1,6	20	4, 6, 8, 12, 20	FZ, TZ, RZ

In case that you did not find the type of saw blades you require in our catalogue, please contact us. We will make them upon your specification.

We also offer complete servicing of PCD saw blades!

pilana.com



pilanawood.com

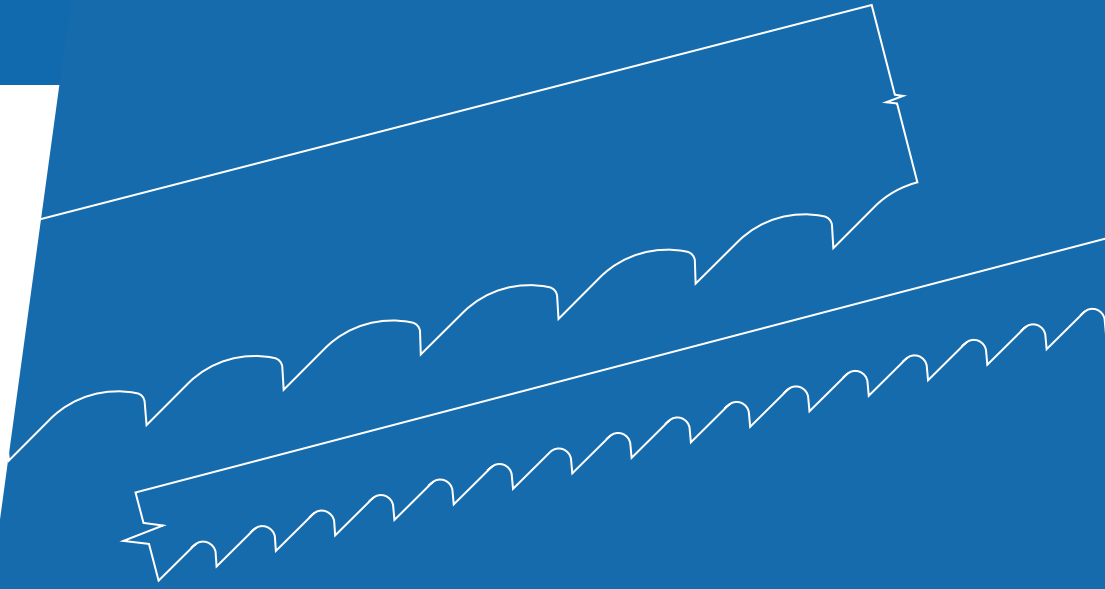

Band Saw Blades for Wood



Dimensions:

Dimensions of band saw blade depend on the machine type and material type.

Width of the band saw blade type 40 – C75 is determined by the smallest radius that is cut in the material. Otherwise the width may be by max. 10 mm wider than width of the flywheel of the particular machine.

Minimum radius (mm)	25	50	100	150	200	300	400	500	600	700
Width of blade (mm)	6	10	15	20	25	30	35	40	45	50

Band saw blades type 40 – WM1, 40 – WM2 the width of blade is determined by machine builder and it is calculated based on the width of the flywheel.

Thickness of band saw blade must not exceed value S1 because material of band saw blade would be too strained while bending and mechanical damage could happen.

$$S_1 = \frac{\text{diameter of welded loop [mm]}}{1000}$$

When choosing the right tooth pitch, the height of cutting material must be considered. We recommend 3 – 5 teeth to be in cut.

Working conditions:

Maximum cutting speed of band saw blade is recommended by the machine builder. Usually the speed is between 20 – 35 m/sec. General rule is that the harder cutting material, the lower cutting speed we use.

General rules for usage:

1. Before you start cutting check if the band saw blade is properly sharpened, set and whether it is not damaged or heated up. Band saw heating can be recognized if blade is purple color even after cooling.
2. Band saw blade must be properly tightened. Please be aware not to tighten the blade too much. This could cause disruption of the blade.

Maximum recommended values of straightening the band saw blade.

Type: 40 C75

Dimensions HxSxT [mm]	Tensile stress [Mpa]	Tensioning strength [N]
6x0,5x4	25	105
8x0,5x5	25	142,5
10x0,6x6	25	211,5
12x0,6x7	30	320
15x0,6x7	30	428
16x0,6x7	30	464
20x0,6x8	30	585
25x0,6x8	30	893
25x0,7x8	30	1006
30x0,7x10	30	1245
35x0,8x10	40	1702
40x0,7x10	45	2190
40x0,8x10	45	2550
45x0,9x12	50	3564
50x0,9x12	50	4014

Type: 40 WM1, 40 WM2

Dimensions HxSxT [mm]	Tensile stress [Mpa]	Tensioning strength [N]
32x0,9x22	40	1840
32x1,0x22	40	2040
32x1,1x22	40	2240
35x0,9x22	40	2050
35x1,0x22	40	2280
35x1,1x22	40	2510
40x0,9x22	45	2700
40x1,1x22	40	2930
50x1,1x22	50	4760

3. Guidance of blade and guiding wheels must be clean from chips and resin. Allowance between guiding and band saw blade may be maximum 0,2mm. The distance between the top guidance from the cutting material should be as little as possible so that blade rigidity is as big as possible.
4. Hold the cutting material with both hands so that your body is not in the same level as the cutting blade. Do not cut material using extra strength.
5. Start cutting after the proper cutting speed is achieved. Do not shorten or slow down the cutting period by friction of the blade against the side of material or slowing against cutting material.
6. While cutting big dimensions it is important to use fixed guidance. While finish sizing the material it is important to use holding device.
7. It is necessary to replace the band saw blade and set it away (even if not dull). Mechanical attributes of band saw blade will remain the same.
8. Do not let the band saw to heat up by any means. If this happens, set away the blade immediately and after cooling set and sharpen it again. You can also check the straightness. To prevent heating it is better to sharpen the blades in time and follow the right cutting conditions.
9. Replace the band saw blade if any break off occurs.
10. After finishing cutting process do not leave the band saw blade straightened in the machine, always loosen it

Service:

Tooth setting is done to 1/2 to 2/3 tooth height and is set by 1/2 to 1/3 over the size of band saw thickness. Tooth setting can be even bigger for soft woods but there must never happen that a piece of wood remains in between the teeth. Please keep the same distance while tooth setting the whole band saw blade. Pay special attention to regularity of setting (max. 0,1 mm). If not, run in of blade might occur on the side where the bigger tooth set is.

Tooth sharpening is done by ceramic disc with medium grain roughness. Tooth face is sharpened. If the blade is extra dull, it is possible to sharpen the tooth back as well. Prevent the tooth to become black from annealing (unwanted stage). While grinding it is needed to keep the radius on tooth bottom. Sharp edge on tooth bottom could cause blade breakage.

Recommendations How to Use Band Saw Blades

The most common causes of trouble while cutting with band saw blades is wrong choice of band saw blade type, dimensions of blade or wrong tooth pitch for particular material. Not adhering to cutting conditions is the second most common problem along with usage of insufficiently set or dull band saw blade.

In the below tab you can find most common problems and their possible solution.

Most common problem	Probable reason	Solution
Broken/ fissured blade	• Wrong tooth pitch	Choose a blade with tooth pitch so that 3-5 teeth are in cut
	• Overstressing of blade	Lower the blade straightness between circling wheels
	• Feed is too high	Lower down-force of material on the blade
	• Teeth are in contact with material before cutting	Adjust allowance between blade/material to minimum 10mm before cutting
	• Diameter of guiding wheels is too small	Use a thinner blade
	• Side press on band saw	Adjust manually
Undercutting	• Blade friction against carrier wheels	Adjust parallelity of wheels
	• High feed	Lower the feed speed
	• Insufficient blade straightness	Straighten the blade
	• Damaged top tooth line	Use a blade with harder teeth (hardened)
	• Big allowance between guiding wheels and blade	Lower the guiding wheels
Rough cut	• Big distance between guidance and material	Adjust distance from guidance
	• High feed	Adjust cutting conditions
Blunting of blade	• Wrong tooth pitch	Use correct tooth pitch
	• Cutting with tooth backs	Turn over the band saw blade
Tooth breaking off	• High cutting speed	Lower the cutting speed
	• High pressure on blade	Lower the feed speed
	• Wrong choice of tooth pitch	Use correct tooth pitch
	• Cutting with tooth backs	Turn over the band saw blade
Twisting of blade	• Dirt in cutting material	Do not cut in places where dirt occurs (stones, metals etc.)
	• Blade stuck in cut	Lower the feed speed
	• Free guiding of blade	Adjust the blade guiding

Safety rules for band saw blade usage

Application:

Band saw blades are used for splitting, cutting off wood logs, woodbase materials and light metal alloys. Band saw blades can be used for mechanical or manual feed speed while following the recommended safety rules.

Unwrapping/packing:

When unwrapping/packing and during manipulation (i.e. when setting up into the machine) please proceed with maximum caution! Danger of getting hurt by very sharp objects.

Transport:

Move the tools in an appropriate packing!
Danger of getting hurt!

Application:

Do not exceed maximum tensioning limit. Make sure the area of tensioning wheels is kept clean.

Tool:

Check the cutting edge. Check the machine set up.

Machine:

It is necessary to stop the machine while tool replacement.

Tool set up:

Set up the tool into the machine and secure it following the manufacturer's specification. Follow the manufacturer's safety rules.

Service:

Always keep to safety instructions.

Proper functioning and safety will be met only when keeping to operating instructions of Pilana Wood s.r.o.

How to use the tool:

- Follow the valid regulations
- Unskilled usage and usage out of purpose is forbidden.
- If not required by national law, use specific objects to protect your eyes, ears and mouth.
- Never leave the machine unattended without monitoring!
- Please clean the band saw blades in time and remove resin. Clean blades have longer life-time and are therefore more economical..

Sharpening/servicing:

Well-timed sharpening and cleaning the blade are basic conditions how to keep the quality and follow the safety rules. It is important to have these activities done by an expert.

Tools are often covered by resin and dust etc. Any dirt negatively influences the cutting performance. To clean the machine use only convenient objects, which do not cause rust or chemical damage to band saw blades.

Material: Natural wood
Application: Cutting massive natural wood
Machine: Mobile band saw machines



40 - Band Saw Blades for Mobile Band Saw Machines

Characteristics:

- » we supply band saw blades welded to requested length or in coils of 25, 50 or 100 m
- » band saw blades type WM1 are for cutting of soft woods
- » band saw blades type WM2 are for cutting of hard woods

Type	Geometry	Application
WM 1	15°/28°	soft wood
WM 2	10°/30°	hard, frozen or soft wood

Type:

- V** – toothed
- R** – toothed, set
- RO** – toothed, set, sharpened
- ROK** – toothed, set, sharpened, hardened

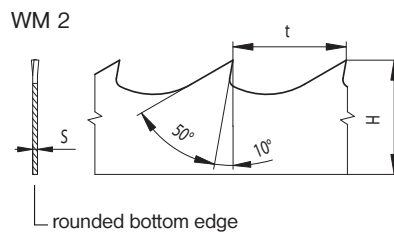
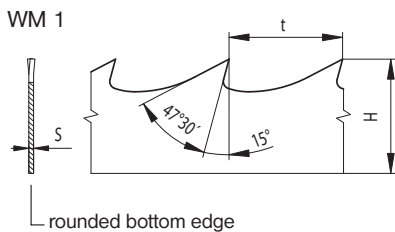

Tooth pitch (t):

22 mm | 22,2 mm

EXPERT

Working time: 2 hours + 12 hours on rest

Basic line of band saws for cutting of soft, hard and frozen wood. This most popular band saw ensures a high quality cut and maximum reliability under all cutting conditions.

Used material: high quality German steel with chromium and vanadium content; hardness 42 - 44 HRc; polished silver surface; rounded bottom edge to prevent cracking; hardness of hardened tips 63 - 65 HRc.

Dimensions H x S (in mm)

35 x 1,0	35 x 1,1
40 x 1,0	40 x 1,1
	50 x 1,1

SILVER MASTER

Working time: 2,5 hours + 12 hours on rest

Premium line of band saws for cutting of soft, hard, frozen and exotic wood. Due to its excellent material properties it meets the most demanding requirements for quality of the cut.

Used material: premium German steel of the highest quality with nickel and molybdenum content; hardness 44 - 46 HRc; polished silver surface; rounded bottom edge to prevent cracking; hardness of hardened tips 63 - 65 HRc.

Dimensions H x S (in mm)

32 x 1,0	32 x 1,1
35 x 1,0	35 x 1,1
40 x 1,0	40 x 1,1

GOLD MASTER

Working time: 3 hours + 12 hours on rest

Top line of band saws for cutting of soft, hard, frozen and exotic wood under the most challenging cutting conditions. Modification with hardened tips is most recommended.

Used material: premium German steel of highest quality with nickel and molybdenum content; hardness 44 - 46 HRc; polished golden surface; rounded bottom edge to prevent cracking; hardness of hardened tips 63 - 65 HRc.

Dimensions H x S (in mm)

32 x 1,07	35 x 1,0
38 x 1,14	40 x 1,0
50 x 1,1	



80 – Scoring Saw Blades for Band Saws

» for removing of bark from logs, while extending the lifespan of the band saw

D	S	d	z	Teeth
180	5,0	20	9	FZ N

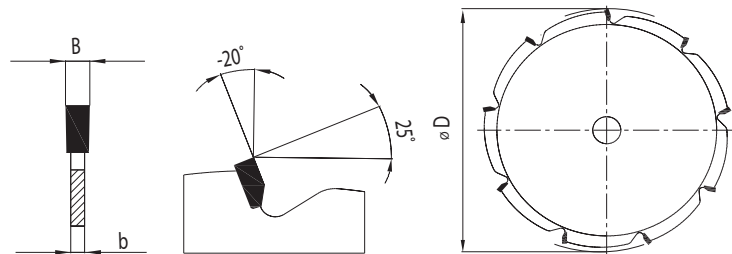

Material:	Natural wood
Application:	Cutting of natural wood
Machine:	Band saw machines



Band Saw Blades for Carpenters

Characteristics:

- » natural wood
- » joinery, carpentry
- » joining band saw machines
- » we produce the following modifications of band saw blades - toothed, set, sharpened, hardened
- » band saws are supplied in coils of 25, 50, 100 m or welded to a particular machine length
- » material type used - carbon steel C 75 – material hardness 42 – 44 HRC

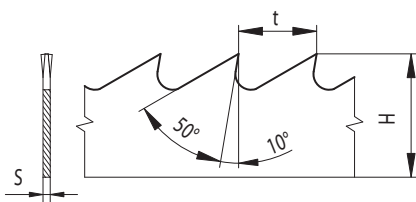

H	S	t	C 75 set	C 75 set and sharpened	C 75 set, sharpened and hardened 64 HRC
6	0,5	4	●	●	●
8	0,5	5	●	●	●
10	0,4	6	●	●	●
10	0,5	6	●	●	●
10	0,6	6	●	●	●
12	0,6	7	●	●	●
15	0,4	7	●	●	●
15	0,5	7	●	●	●
15	0,6	7	●	●	●
15	0,7	7	●	●	●
20	0,4	7	●	●	●
20	0,4	8	●	●	●
20	0,6	8	●	●	●
20	0,7	8	●	●	●
25	0,6	8	●	●	●
25	0,7	8	●	●	●
30	0,7	10	●	●	●
35	0,7	10	●	●	●
40	0,7	10	●	●	●
45	0,9	12	●	●	●
50	0,9	12	●	●	●



BAND SAW BLADES FOR WOOD

A large rectangular area with horizontal blue lines, intended for taking notes.

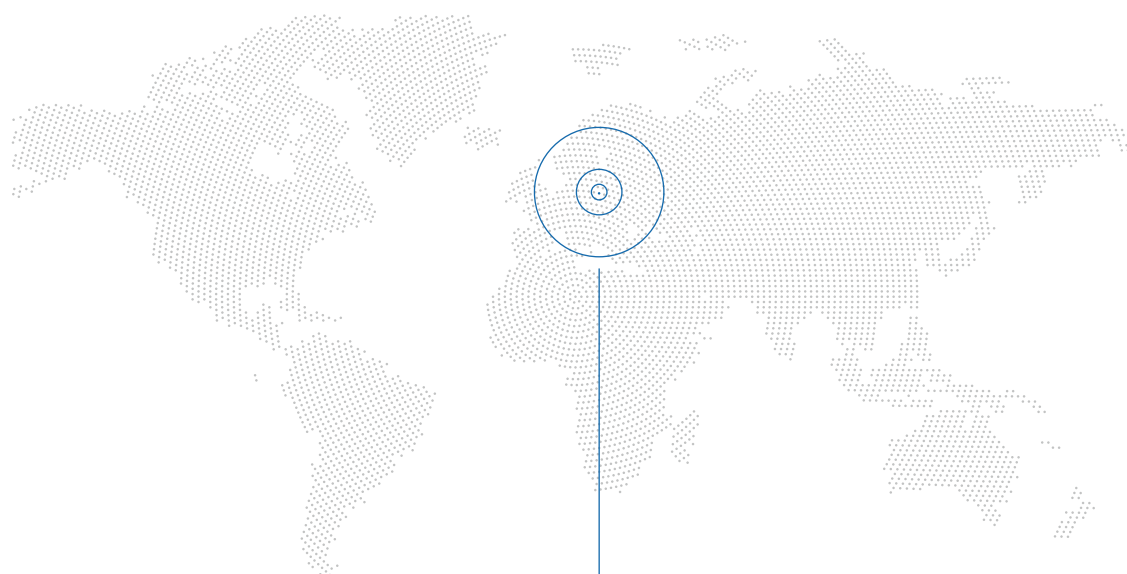

PILANA Wood s.r.o.

Nádražní 804
768 24 Hulín
Czech Republic

Tel.: +420 573 328 254
Fax: +420 573 328 565
E-mail: info@pilana.cz
wood@pilana.cz

www.pilanawood.com



pilana.com

2021

pilanawood.com



EUROPEAN UNION
European Regional Development Fund
Operational Programme Enterprise
and Innovations for Competitiveness